

# ICOM

## INSTRUCTION MANUAL

DUAL BAND FM TRANSCEIVERS

# IC-Z1A IC-Z1E

This device complies with part 15 of the FCC Rules. Operation is subject to the following conditions: (1) This device may not cause harmful interference, and (2) this device must accept any interference received, including interference that may cause undesired operation.

Icom Inc.



## IMPORTANT

**READ ALL INSTRUCTIONS** carefully and completely before using the transceiver.

**SAVE THIS INSTRUCTION MANUAL**—This instruction manual contains important operating instructions for the IC-Z1A and IC-Z1E.

## EXPLICIT DEFINITIONS

**CAUTION:** Equipment damage may occur.

**NOTE:** If disregarded, inconvenience only. No risk of personal injury, fire or electric shock.

 This manual describes the UT-93 TONE SQUELCH UNIT as an option. However, it is standard in the U.S.A. version.

## CAUTIONS

**NEVER** connect the transceiver to an AC outlet or to a power source of more than 16 V DC. Such a connection may pose a fire hazard.

**NEVER** connect the transceiver to a power source using reverse polarity without a fuse (or with a more than 4 A fuse). This connection will ruin the transceiver.

**NEVER** attempt to charge alkaline or dry cell batteries. Beware that external DC power connections will charge batteries inside the battery case. This will damage not only the battery case but also the transceiver.

**NEVER** allow children to touch the transceiver.

**AVOID** using or placing the transceiver in direct sunlight or in areas with temperatures below  $-10^{\circ}\text{C}$  ( $+14^{\circ}\text{F}$ ) or above  $+60^{\circ}\text{C}$  ( $+140^{\circ}\text{F}$ ).

**DO NOT** detach or attach the front panel while power is turned ON.

**BE CAREFUL!** When transmitting for a long time at high output power, the rear panel will become hot.

The use of non-Icom battery packs/chargers may impair transceiver performance and invalidate the warranty.

Even when the transceiver power is OFF, a slight current still flows in the circuits. Remove the battery pack or case from the transceiver when not using the transceiver for a long time. Otherwise, the battery pack or installed dry cell batteries will become exhausted.

## UNPACKING

Accessories included with the transceiver:

	Qty.
① Extension cable (OPC-500).....	1
② Antenna.....	1
③ Handstrap.....	1
④ Battery pack (BP-171 or BP-180) or battery case (BP-170) attached to transceiver.....	1
⑤ Belt clip and screws.....	1 set
⑥ Wall charger*.....	1

\* Not supplied with battery case versions.

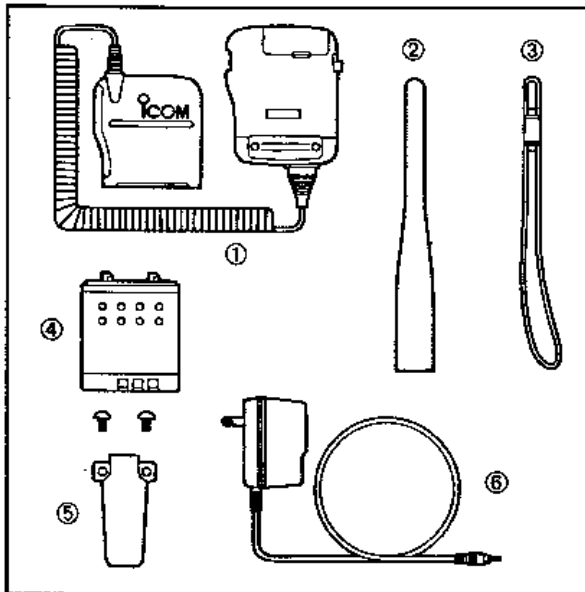

## FIRST APPLYING POWER

- ① Charge the battery pack or install alkaline batteries into the battery case (pgs. 10, 11).
- ② Attach or detach the detachable panel as desired (p. 8).
- ③ Turn power ON.
  - Push and hold **POWER** for 2 sec.

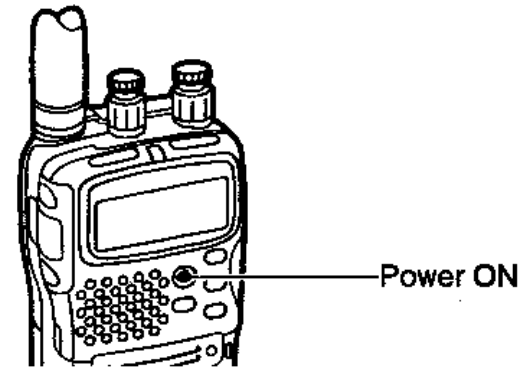

- ④ Set the audio level—while holding [VOL], rotate [DIAL].
  - The volume can be set separately for each band.
  - [◀▽]/[▶△] or [UP]/[DN] can be used to adjust the main band's volume.
  - The volume switch action can be varied in set mode (p. 51).

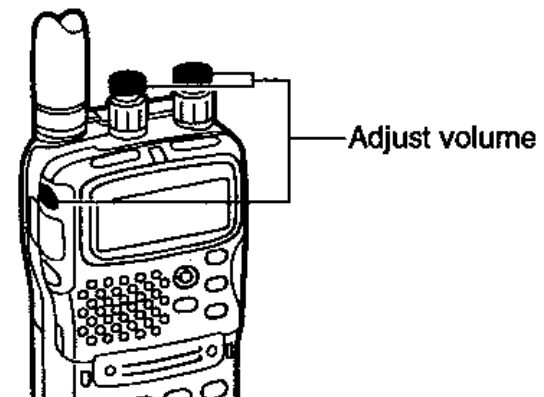

---

# TABLE OF CONTENTS

---

CAUTIONS.....	i	5 BASIC OPERATION.....	16-19
UNPACKING .....	ii	■ Receiving.....	16
FIRST APPLYING POWER.....	ii	■ U by U and V by V functions.....	17
TABLE OF CONTENTS.....	iii	■ Single band function.....	17
<b>1 PANEL DESCRIPTION.....</b>	<b>1-6</b>	■ Transmitting .....	18
■ Front and side panels .....	1	■ Crossband full duplex.....	19
■ Top panel.....	2	<b>6 REPEATER OPERATION.....</b>	<b>20-23</b>
■ Keypad and detachable panel.....	3	■ Operation.....	20
■ Function display.....	5	■ Tone information.....	20
<b>2 ACCESSORY ATTACHMENT.....</b>	<b>7-8</b>	■ Subaudible tones.....	21
<b>3 BATTERY PACK CHARGING .....</b>	<b>9-11</b>	■ Offset frequency.....	21
■ Battery pack charging.....	9	■ Repeater memory.....	22
■ Charging precautions .....	9	■ Auto repeater function .....	22
■ About the battery pack .....	9	■ Tone scan .....	23
■ Charging connections.....	10	<b>7 MEMORY OPERATION .....</b>	<b>24-28</b>
■ Battery case .....	11	■ General description .....	24
<b>4 SETTING A FREQUENCY.....</b>	<b>12-15</b>	■ Memory channel selection.....	24
■ VFO and memory modes .....	12	■ Programming after channel confirmation .....	25
■ Main band.....	12	■ Programming with channel selection.....	26
■ Setting via the keypad .....	13	■ Memory names.....	27
■ Setting via the $\Delta/\nabla$ or UP/DN keys.....	13	■ Transferring memory contents.....	28
■ Presetting for the tuning dials.....	14	<b>8 CALL CHANNEL OPERATION.....</b>	<b>29</b>
■ Using the tuning dials .....	15	■ Accessing a call channel .....	29
■ Lock function .....	15	■ Transferring call channel contents .....	29
■ Beep tones on/off .....	15	■ Programming a call channel.....	29

<b>9 SCAN OPERATION</b> .....	<b>30–34</b>		
■ Scan types .....	30		
■ Full scan .....	31		
■ Programmed scan .....	31		
■ Memory scan .....	32		
■ Memory skip scan.....	32		
■ Skip channel setting.....	33		
■ Scan resume condition .....	33		
<b>10 PRIORITY WATCH</b> .....	<b>34</b>		
■ Priority watch types .....	34		
■ Priority watch operation.....	34		
<b>11 CLOCK AND TIMERS</b> .....	<b>35–37</b>		
■ Clock operation .....	35		
■ Timer mode .....	36		
■ Auto power-off .....	36		
■ Power-on/power-off timers .....	37		
<b>12 DTMF MEMORY</b> .....	<b>38</b>		
■ Programming a DTMF code.....	38		
■ Transmitting a DTMF code.....	38		
<b>13 PAGER AND CODE SQUELCH</b> .....	<b>39–46</b>		
■ Pager function .....	39		
■ Code channel.....	40		
■ Code programming .....	41		
■ Pager operation.....	41		
■ Code squelch operation .....	43		
		■ Message function .....	44
		<b>14 POCKET BEEP AND TONE SQUELCH</b> .....	<b>47–48</b>
		■ Optional UT-93 installation .....	47
		■ Pocket beep operation.....	48
		■ Tone squelch operation .....	48
		<b>15 OTHER FUNCTIONS</b> .....	<b>49–52</b>
		■ Power saver.....	49
		■ Battery voltage indication .....	49
		■ LCD lighting.....	50
		■ LCD contrast .....	50
		■ PTT lock function .....	51
		■ External speaker selection .....	51
		■ Volume switch .....	51
		■ DTMF speed .....	51
		■ Optional HM-75A functions .....	52
		■ All reset .....	52
		■ Partial reset.....	52
		<b>16 MODE ARRANGEMENT</b> .....	<b>53–54</b>
		<b>17 TROUBLESHOOTING</b> .....	<b>55</b>
		<b>18 SPECIFICATIONS</b> .....	<b>56</b>
		<b>19 OPTIONS</b> .....	<b>57–58</b>

# PANEL DESCRIPTION

## ■ Front and side panels

**UP/DOWN SWITCHES [UP]/[DN]**  
(pgs. 13, 24, 31)

- Increment/decrement frequency or memory channel in VFO or memory modes, respectively.
- Change scan direction during scanning; start scanning when pushed and held.
- Adjust the main band's volume while [VOL] is pushed.

**VOLUME SWITCH [VOL]** (p. 16)  
Sets the tuning dial and [UP]/[DN] switches as volume controls.

**PTT SWITCH [PTT]** (p. 18)  
Push and hold to transmit; release to receive.

**LIGHT SWITCH [LIGHT]** (p. 50)

- Activates backlighting for 5 sec.
- [FUNC] then [LIGHT] manually turns the backlighting ON/OFF.

**SPEAKER/MICROPHONE**

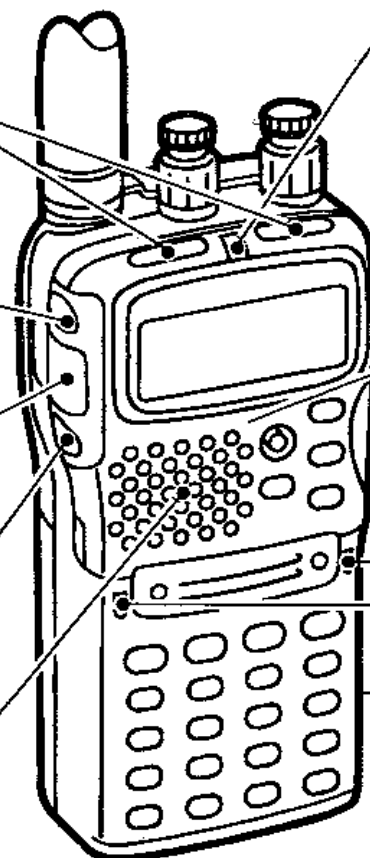

**TX INDICATOR** (p. 18)

**DETACHABLE PANEL RELEASE** (p. 8)  
Push upwards to remove the detachable panel.

**DETACHABLE PANEL** (p. 8)

**BATTERY PACK RELEASE** (p. 11)  
Push to open the latch for battery pack removal.

**RX INDICATORS** (p. 16)  
Left indicator lights while receiving on the VHF band display; right indicator lights while receiving on the UHF band display.

**BATTERY PACK/CASE** (p. 9-11)

## ■ Top panel

### EXTERNAL DC POWER JACK

[DC13.5V] (pgs. 10, 11)

Allows operation with a 13.5 V DC power source using the optional cables, CP-12 or OPC-254.

**CAUTION:** Operation with an external DC power source simultaneously charges batteries inside the battery case or the battery pack. This may cause battery leakage and damage the transceiver or cause battery overcharging and shorten the life of the battery pack, respectively.

### ANTENNA CONNECTOR

(p. 7)

Connects the supplied antenna.

### TUNING DIALS [DIAL] AND SQUELCH CONTROLS [SQL]

(pgs. 14–16)

[DIAL] sets the operating frequencies, memory channels, set mode contents, etc. for the VHF and UHF bands.

[SQL] adjusts the squelch threshold points for noise mute.

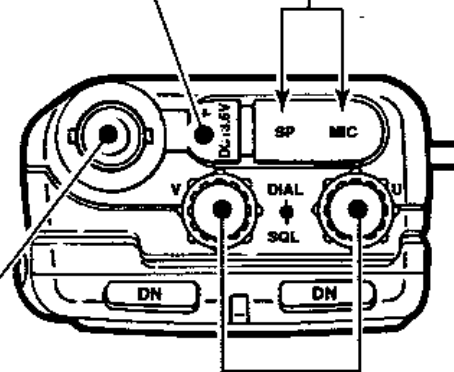

### EXTERNAL SPEAKER AND MICROPHONE JACKS [SP]/[MIC]

Connect an optional speaker-microphone or headset, if desired. The internal microphone will not function when either is connected. (See p. 58 for options.)

#### ◇ External connection

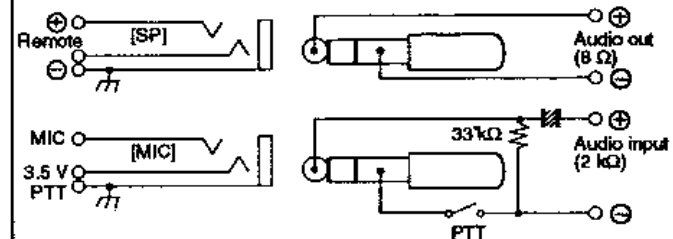

The above connection does not apply when a condenser microphone is connected.

#### ◇ External audio output

Audio output from the [SP] jack can be selected for VHF and/or UHF using set mode. When connecting a TNC etc., set the undesired band audio to the internal speaker. (p. 51)





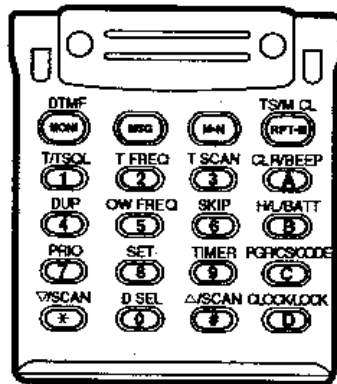
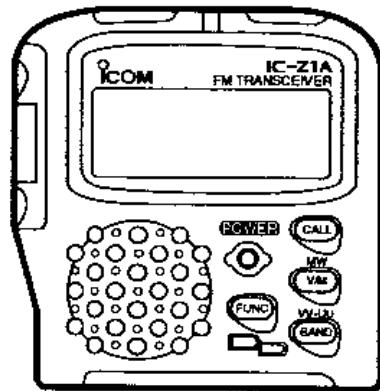







# 1 PANEL DESCRIPTION

## Keypad and detachable panel



KEY	FUNCTION	SECONDARY FUNCTION ( After [FUNC])
T/TSQL ①	<ul style="list-style-type: none"> <li>• Input the appropriate digit for frequency selection while in VFO mode (p. 13) or for a memory channel while in memory mode (p. 24).</li> <li>• Transmit the appropriate DTMF code while transmitting. (p. 38)</li> </ul>	<ul style="list-style-type: none"> <li>• Turns subaudible tone encoder ON/OFF (IC-Z1A only).</li> <li>• Activates the following functions when an optional* tone squelch unit is installed: subaudible tone encoder, pocket beep, tone squelch, non-tone operation. (pgs. 20, 48).</li> </ul>
T FREQ ②		Selects tone frequency setting mode. (p. 21) Eur., Italy, U.K. versions: optional tone squelch unit necessary.
T SCAN ③		Activates tone scan during optional* tone squelch operation. (pgs. 23, 48)
DUP ④		Selects the duplex direction in this sequence: – duplex → + duplex → simplex. (p. 20)
OW FREQ ⑤		Selects offset frequency writing mode. (p. 21)
SKIP ⑥		Sets the selected memory channel as a skip memory channel in memory mode. (p. 33)
PRIO ⑦		Starts the priority watch. (p. 34)
SET ⑧		Enters set mode. (pgs. 53, 54)
TIMER ⑨		Enters timer mode. (p. 36)
D SEL ⑩		Selects the dial select step. (p. 14)
▽/SCAN [*]	<ul style="list-style-type: none"> <li>• Change freq. (p. 13)</li> <li>• Start full/mem scan.</li> <li>• Adjust volume. (p. 16)</li> </ul>	Starts/stops programmed scan or memory skip scan. (p. 30)
△/SCAN [#]		

\*Standard for the U.S.A. version.

KEY	FUNCTION	SECONDARY FUNCTION ( After [FUNC])
	Turns power ON and OFF when pushed for 1 sec. (p. ii)	The same as the primary function at left.
	Selects the call channel. (p. 29)	Activates the AF mute function. (p. 16)
	Toggles between VFO and memory mode. (p. 12)	Writes VFO contents into a memory. (p. 25) Transfers a memory to VFO mode. (p. 28)
	Toggles the main band between VHF and UHF. (p. 12)	Toggles between V by V and U by U functions. (p. 17) Turns the sub band OFF when pushed and held. (p. 17)
	<ul style="list-style-type: none"> <li>• Opens the squelch. (p. 16)</li> <li>• Sends a DTMF code when pushed during Tx. (p. 38)</li> </ul>	Displays the DTMF memory. (p. 38)
	<ul style="list-style-type: none"> <li>• Toggles between Tx/Rx messages when pushed. (p. 53)</li> <li>• Sends a message when pushed during Tx. (p. 45)</li> </ul>	Turns the message receive function ON and OFF. (p. 44)
	Toggles between freq. and name indication. (p. 27)	Selects memory name writing mode. (p. 27)
	Calls up a repeater memory. (p. 22)	<ul style="list-style-type: none"> <li>• Sets a tuning step in VFO mode. (p. 14)</li> <li>• Clears a memory channel in memory mode.</li> </ul>
	<ul style="list-style-type: none"> <li>• Turns OFF some functions.</li> <li>• Clears frequency input before entry. (p. 13)</li> </ul>	Toggles the beep function ON and OFF. (p. 15)
	Selects output power. (p. 18)	Displays the battery condition. (p. 49)
	Selects pager, code squelch or non-code squelch operation. (pgs. 39–46)	Selects code setting mode. (p. 41)
	Toggles the clock display ON and OFF. (p. 35)	Selects one of the key lock functions. (p. 15)

# 1 PANEL DESCRIPTION

## ■ Function display

**U BY U INDICATOR** (p. 17)  
Appears when the U by U or V by V function (two frequencies in one band) is in use.

**FUNCTION INDICATOR** (pgs. 3, 4)  
Appears when the function switch [FUNC] is activated, indicating that the secondary function of switches can be accessed.

**FREQUENCY READOUTS**  
Show the operating frequency, set mode contents, etc.

- The decimal point of the frequency flashes during scan. (pgs. 30–33)
- “P” or “C” appears in place of the 100 MHz digit while pager or code squelch is in use, respectively. (pgs. 39–43)

**LOW POWER INDICATOR**

- “LOW” appears when low output power is selected. (p. 18)
- “E LOW” appears when the economical low power is selected. (p. 18)
- No indicator appears when high output power is selected.

**MAIN BAND INDICATORS** (p. 12)  
Appears in one of two positions to show the main band for transmitting and function control.

**DUPLEX INDICATOR** (p. 20)  
“–DUP” or “DUP” appears when semi-duplex operation (repeater operation) is in use. Indicates main band condition only.

**AUTO POWER-OFF INDICATOR** (p. 36)  
Appears when the auto power-off function is in use.

**PTT LOCK INDICATOR** (p. 51)  
Appears when the PTT switch is electronically locked.

**LOCK INDICATOR** (p. 15)  
Indicates that one of the lock functions is activated.

- “ALL LOCK” and “KEY LOCK” are available.

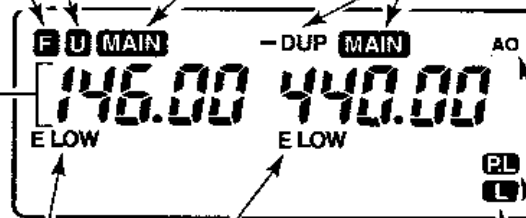

**MESSAGE INDICATOR** (p. 44)  
Appears when the message function is activated.

**TONE INDICATOR** (p. 20)

- “T” appears when the subaudible tone encoder is in use\*, the following indicators appear when an optional tone squelch unit is installed:
- “T SQL” appears when the tone squelch is in use. (p. 48)
- “T SQL ((•))” appears when the pocket beep function is in use. (p. 48)

\*For the Eur., Italy and U.K. versions, all indicators appear only when the optional tone squelch unit is installed.

**ALPHANUMERIC READOUTS**

Show the selected memory channel number in memory mode.

- The current time is displayed when the clock is activated. (p. 35)
- Memory names can be selected instead of channel numbers. (p. 27)
- Messages appear here when receiving a message while the message functions is in use. (p. 44)
- Various other indications appear in set mode, at power ON, etc. depending on programming.

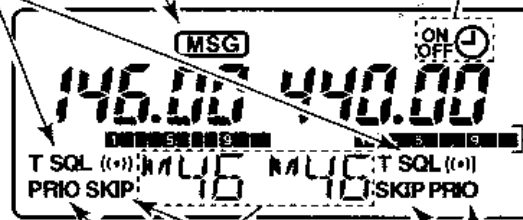

**TIMER INDICATOR** (p. 37)

“⌚” appears with “ON” and/or “OFF” as follows:

- “ON” appears when the power-on timer is in use.
- “OFF” appears when the power-off timer is in use.

**S/R F INDICATORS**

- Show the relative signal strength while receiving. (p. 16)
- Show the output power selection while transmitting. (p. 18)

**SKIP INDICATOR** (p. 33)

Appears when a selected memory channel is set as a skip channel.

**PRIORITY INDICATOR** (p. 34)

Appears when the priority watch is activated; flashes when the watch is paused.

## ACCESSORY ATTACHMENT

### ◇ Antenna

Insert the supplied antenna into the antenna connector and rotate the antenna as shown in the diagram below.

Keep the jack cover attached when jacks are not in use to avoid bad contacts.

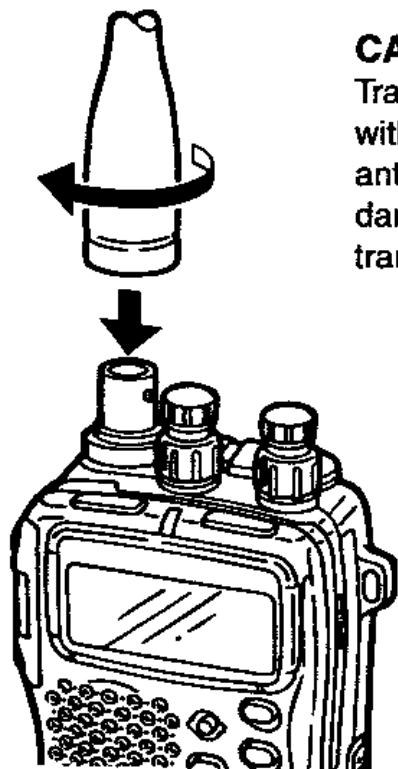

**CAUTION:**  
Transmitting without the antenna may damage the transceiver.

### ◇ Belt clip

Remove the plastic screws, then attach the belt clip with the supplied metal screws. Conveniently attaches to your belt.

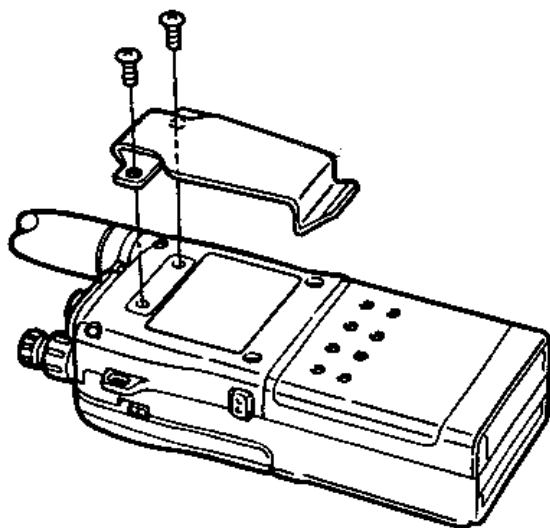

### ◇ Handstrap

Attach the handstrap as shown in the figure below. Facilitates carrying.

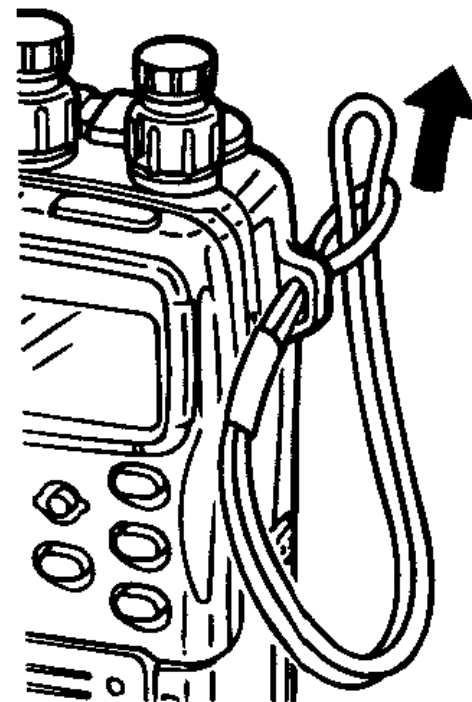

### ◇ Operating with the detachable panel

Make sure the power is turned OFF, then:

- ① While pushing the detachable panel release button upwards, pull the panel (from the top) away from and free of the transceiver as illustrated at right.
- ② Align the connectors on the bottom of the detachable panel with those on the OPC-500, then click the panel into place as illustrated at the far right.
- ③ Align the connectors on the bottom of the dummy panel end of the OPC-500 with those on the transceiver, then click the top of the dummy panel into place.

**CAUTION:** The transceiver power *must* be turned OFF while removing or attaching the detachable panel; otherwise, the transceiver may be damaged.

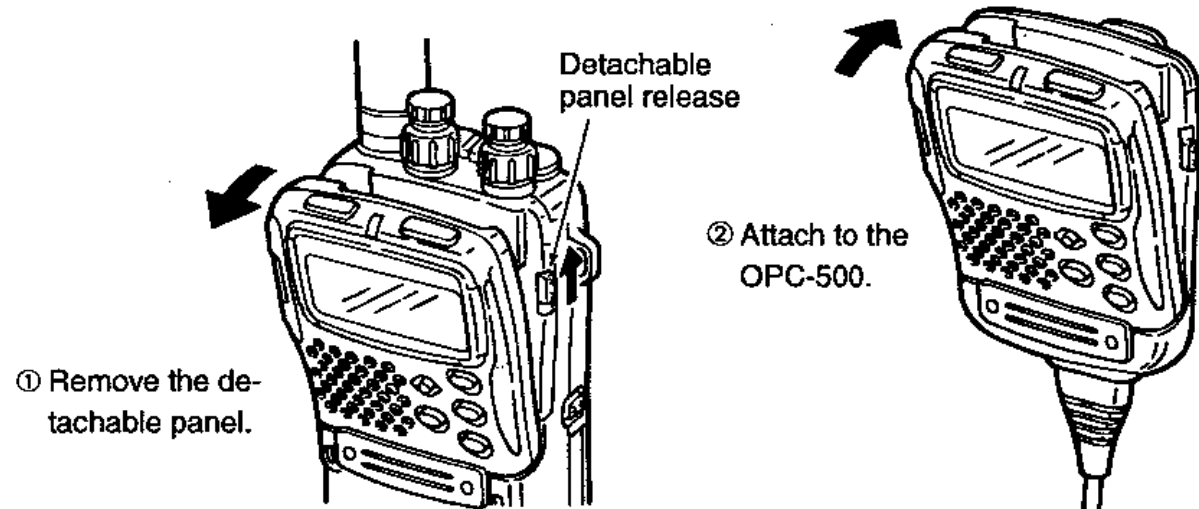

① Remove the detachable panel.

② Attach to the OPC-500.

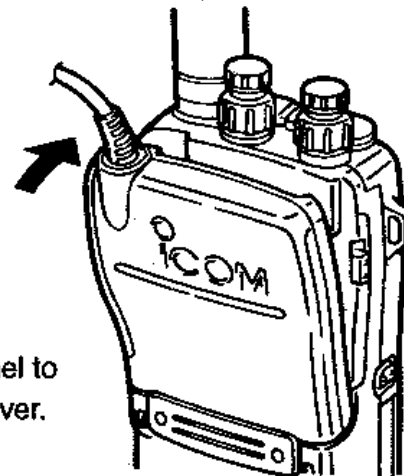

③ Attach the dummy panel to the transceiver.

### CONVENIENT

When operating the transceiver via the detachable panel:

- use the lock function to lock the keypad only—preventing accidental key input.
- use set mode to set the backlighting for the function display only—saving battery power that would be used to backlight the keypad also.

## ■ Battery pack charging

The supplied\* BP-171 or BP-180 BATTERY PACK includes rechargeable Ni-Cd batteries and can be charged approx. 300 times. Charge the battery pack before first operating the transceiver or when the battery pack becomes exhausted. (pgs. 10, 11).

\*Optional for versions which come with the BP-170 BATTERY CASE.

If you want to be able to charge the battery pack more than 300 times, the following points should be observed:

1. Avoid overcharging. The charging period should be less than 48 hours.
2. Use the battery until it becomes almost completely exhausted under normal conditions. We recommend battery charging just after transmitting becomes impossible.

## ■ Charging precautions

**NEVER** attempt to charge dry cell batteries. This will cause internal liquid leakage and damage the battery case and transceiver.

**NEVER** connect two or more chargers at the same time.

Charging may not occur under temperatures of 10°C (+50°F) or over temperatures of +40°C (104°F).

## ■ About the battery pack

### ◇ Operating period

Depending on the attached battery pack, the operating period of the transceiver varies. Refer to the table below.

BATTERY PACK	OUTPUT VOLTAGE	BATTERY CAPACITY	OUTPUT POWER (UHF, HIGH)	OPER. PERIOD (Approx.)	
				VHF	UHF
BP-171	4.8 V	700 mAh	1.5 W	5 h 50 m	4 h 20 m
BP-172	4.8 V	950 mAh	1.5 W	7 h 50 m	6 h 00 m
BP-173	9.6 V	650 mAh	5 W	3 h 20 m	2 h 50 m
BP-180	7.2 V	600 mAh	3.5 W	3 h 20 m	2 h 50 m

**Condition:** Tx (high) : Rx : Standby (power saved)= 1:1:8 (min.)  
Tx and Rx operated on the VHF band, UHF in standby.  
Operating periods are estimated values and vary depending on output power temperature, etc.

### ◇ Battery pack life

When the operating period becomes extremely short even after charging the battery pack fully, a new battery pack is needed.

### ◇ Recycling information (U.S.A. only)

The product that you purchased contains a rechargeable battery. The battery is recyclable. At the end of its useful life, under various state and local laws, it may be illegal to dispose of this battery into the municipal waste stream. Check with your dealer or local solid waste officials for details in your area for recycling options or proper disposal.

## ■ Charging connections

### ◇ Regular charging

Attach the supplied\* battery pack or optional BP-172 or BP-173; then, connect the supplied\* wall charger via an AC outlet as shown below.

\*Optional for versions which include a battery case.

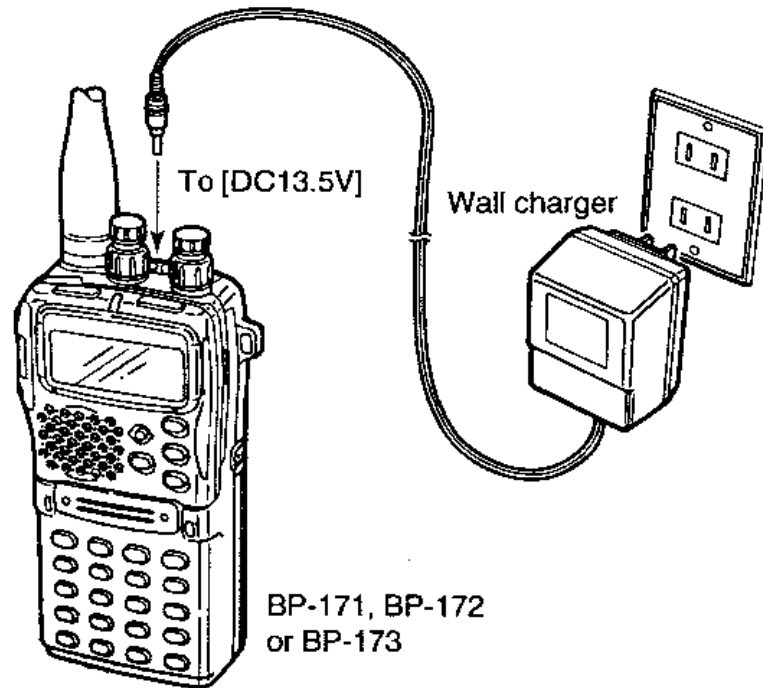

### Charging periods:

15 hours (w/BP-171, BP-173 or BP-180)  
20 hours (w/BP-172)

### ◇ Rapid charging with the optional BC-79

① Insert the AD-51A into the charging slot of the BC-79.

② Insert the AD-51B into the groove in the AD-51A (front-facing side of the AD-51A).

③ Insert the battery pack, either by itself or attached to the transceiver, into the AD-51B.

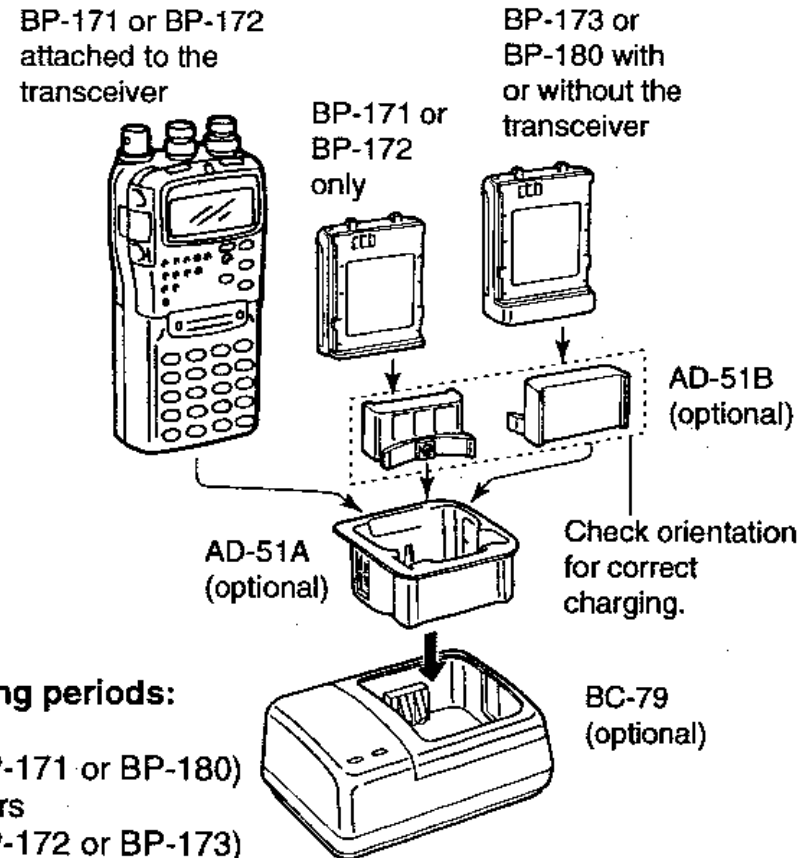

### Charging periods:

1 hour  
(w/BP-171 or BP-180)  
1.5 hours  
(w/BP-172 or BP-173)

### 3 BATTERY CHARGING

#### ◇ Operation with an optional cable

Connect an optional cable to the transceiver as illustrated below. Be careful of battery overcharging as the connected battery is charged simultaneously.

**CAUTION:** Remove dry cell batteries from the BP-170 BATTERY CASE when it is in use.

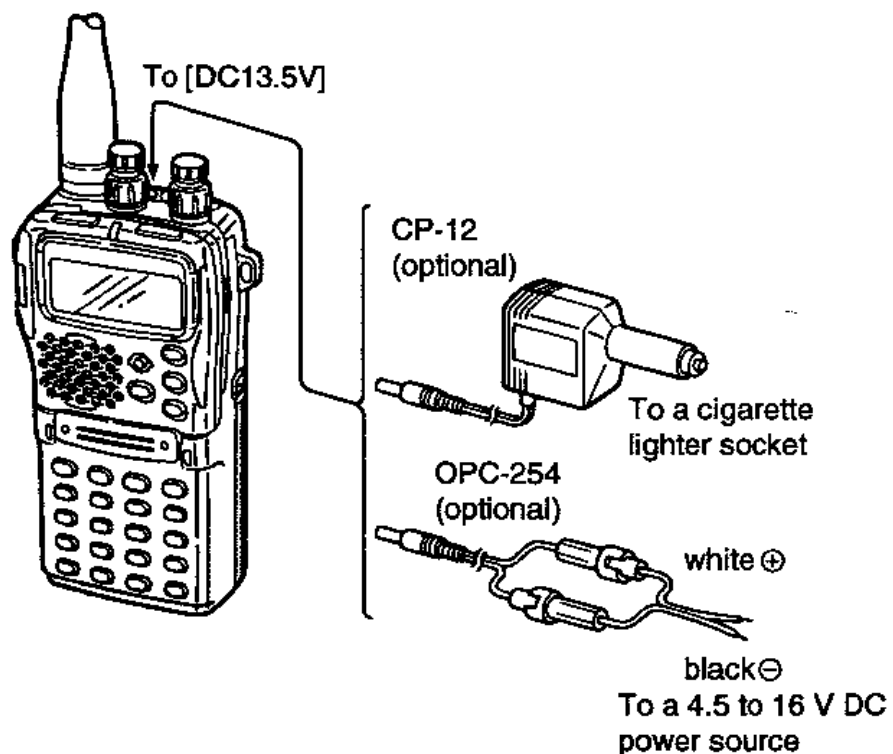

#### ■ Battery case

When using a battery case attached to the transceiver, install 4 AA(R6) size alkaline batteries as illustrated below.

Remove the case from the transceiver.

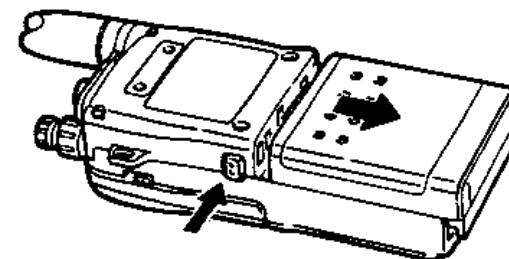

Open the case.

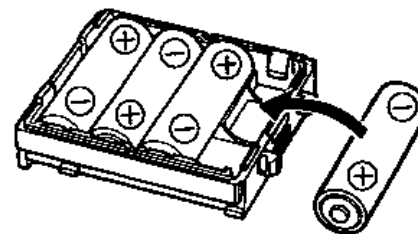
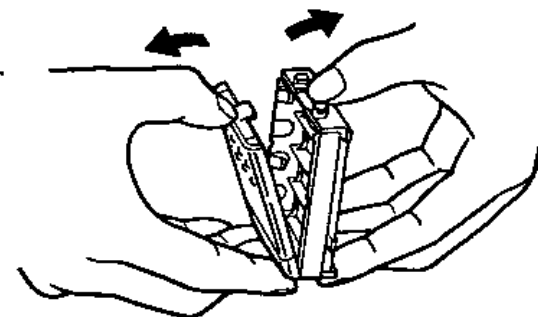

Install 4 AA(R6) size dry cell batteries into the battery case.

## ■ VFO and memory modes

This transceiver has 2 normal operating modes: VFO mode and memory mode. You can select VFO mode or memory mode independently on each band. Push [V/M] to toggle VFO and memory modes. (pgs. 13–24)

### VFO mode (for setting a frequency):

This mode is used for setting a desired frequency within the band range.

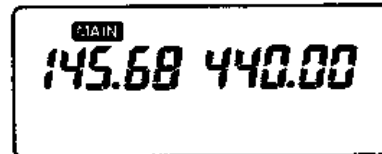

"M" is not indicated

### Memory mode:

This mode is used for operation of memory channels which have programmed frequencies. 46 memory channels (plus 3 pairs of scan edges) are available to store 52 different frequencies.

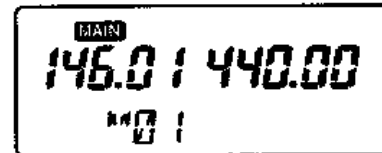

"M" is indicated

### What is VFO?

VFO is an abbreviation of Variable Frequency Oscillator. Frequencies for transmitting and receiving are generated and controlled by the VFO.

## ■ Main band

This transceiver can receive VHF and UHF band signals simultaneously. To change frequency or to activate a function, you must designate the band, VHF or UHF, as the main band. All switches affect the designated main band only.

The [BAND] switch toggles the VHF and UHF bands as the main band.

• "MAIN" appears above the main band.



Band switch

Main band indicator

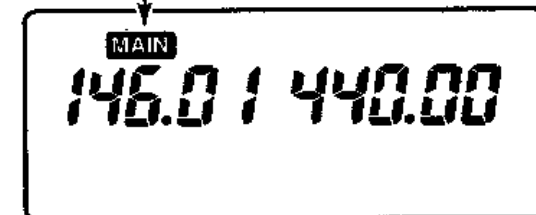

## 4 SETTING A FREQUENCY

### ■ Setting via the keypad

- ① Select VHF or UHF with [BAND].
- ② Select VFO mode with [V/M].
- ③ Push 4 appropriate digit keys, starting from the 1 MHz digit, to input a frequency.
  - When a wrong digit is mistakenly input, push [CLR] to clear the input, then start again.
  - “0,” “2,” “5” or “7” are acceptable for the 1 kHz digits (depending on the 10 kHz digit).

### ■ Setting via the $\nabla/\Delta$ or DN/UP keys

- ① Select the VHF or UHF band with [BAND].
- ② Select VFO mode with [V/M].
- ③ Push either [ $\nabla$ ]/[ $\Delta$ ] or [DN]/[UP] to change the frequency.
  - The frequency changes according to the tuning step (p. 14).
  - Pushing the key for more than 0.5 sec. will activate full scan.
  - If the scan is started, push [ $\nabla$ ]/[ $\Delta$ ] or [DN]/[UP] again to stop the scan.

[EXAMPLE]: Setting the frequency to 145.360 MHz.

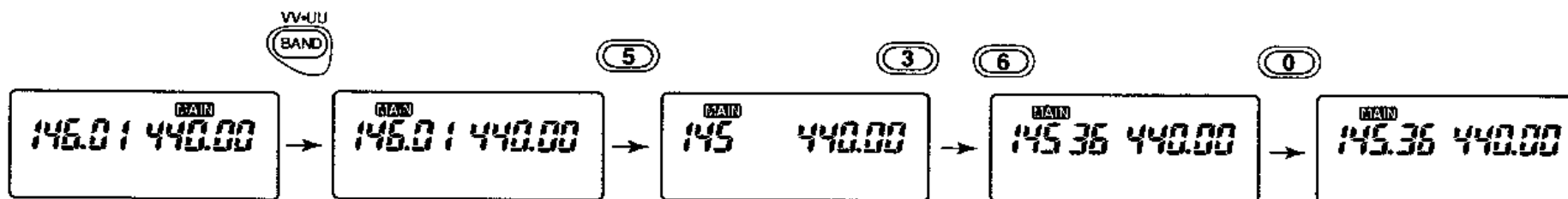

[EXAMPLE]: Setting the frequency to 442.3875 MHz.

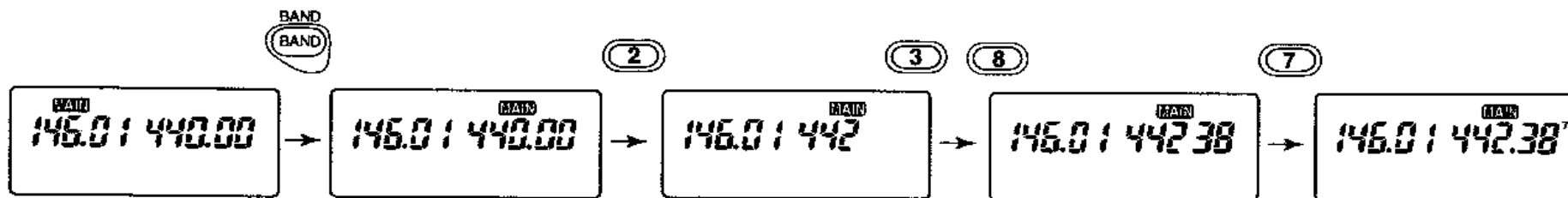

## ■ Presetting for the tuning dials

### ◇ Tuning step selection

Tuning steps can be selected for each band. This transceiver has 8 tuning steps as follows:

- 5 kHz
- 10 kHz
- 12.5 kHz
- 15 kHz
- 20 kHz
- 25 kHz
- 30 kHz
- 50 kHz

- ① Select VHF or UHF with [BAND].
- ② Select VFO mode with [V/M].
- ③ Push [FUNC] then [(RPT·M)TS] to enter the tuning step setting condition.
  - Previously selected tuning step appears.
- ④ Rotate [DIAL] to select the desired tuning step.
- ⑤ Push [CLR] to return to VFO mode.

**NOTE:** For convenience, select a tuning step that matches the frequency intervals of repeaters in your area.

### [DISPLAY EXAMPLE]

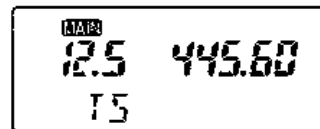

12.5 kHz tuning step (VHF)

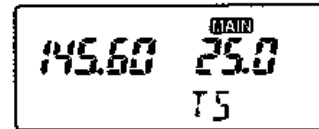

25 kHz tuning step (UHF)

### ◇ Setting a dial select step

In VFO mode, rotating [DIAL] while “” appears (after [FUNC] is pushed) changes the frequency in 100 kHz or 1 MHz steps.

This function is useful for quick tuning and can be set individually for each band.

- ① Select the VHF or UHF with [BAND].
- ② Select VFO mode with [V/M].
- ③ Push [FUNC] then push [D SEL] once or twice to set the dial select step.
  - The selected digit, (100 kHz or 1 MHz) blinks.
- ④ Push [FUNC] then rotate [DIAL] to change the frequency using dial select tuning.

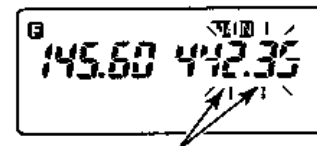

Selected digit, 1 MHz or 100 kHz, flashes while setting the dial select step.

## 4 SETTING A FREQUENCY

### ■ Using the tuning dials

- ① Select the VHF or UHF band with [BAND].
- ② Select VFO mode with [V/M].
- ③ Rotate [DIAL] to set the frequency.
- ④ To change the frequency quickly, push [FUNC], then rotate the tuning dial.
  - See p. 14 for details on how to select a dial select step.

### ■ Lock function

The lock function prevents accidental frequency changes and accidental function access.

- ① Push [FUNC], then push [ⓄLOCK] once or twice to turn the function ON.

•“KEY”:for panel detach operation.

Locks most keys on the transceiver's main body only (except for [VOL], [SQL], and [MONI]).

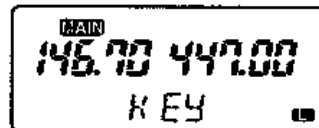

•“ALL”:for general operation. Locks most keys on the transceiver (except for [VOL], [SQL], [MONI], [PTT] and [LIGHT]).

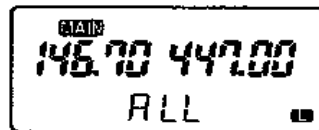

- ② Repeat the above step to turn the function OFF.

### ■ Beep tones on/off

The confirmation beep tones, which sound each time a switch or key is pushed, can be turned ON or OFF, as desired.

- ➔ Push [FUNC] then [ⓄBEEP] to toggle the beep tones ON and OFF.

## ■ Receiving

- ① Turn power ON.
- ② Set the VHF and UHF band's audio levels.
  - See below.
- ③ Set the VHF and UHF frequencies with [BAND] and their respective tuning dials.

### When a signal is received:

- ➔ The RX indicator (VHF or UHF) lights green.
- ➔ Squelch opens and audio is emitted from the speaker.
- ➔ The receiving band's S/RF indicator shows the relative signal strength.

### ◇ Setting volume

Audio output for the transceiver is adjusted using the [VOL] switch and is independently adjustable for each band. The action of [VOL] can be adjusted in set mode to suit your preference (p. 51).

- ① Rotate [SQL] maximum counter-clockwise.
- ② While pushing [VOL], rotate [DIAL] to adjust the audio.
  - "V00" to "V16" appears while [VOL] is activated.
- ③ Rotate [SQL] clockwise until noise is just muted.
  - Each band's audio must be adjusted separately.

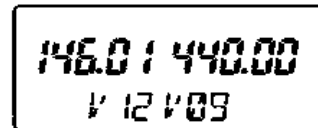

### ◇ Monitor function

This function is used to listen to weak signals without disturbing the squelch setting. When receiving a signal that is too weak to open the squelch completely, push and hold [MONI].

- This function is available for the main band only.
- When duplex is on for repeater operation, the transmitting frequency can be monitored with [MONI].

### ◇ Audio mute

This function allows you to mute the audio temporarily and then return to the previous audio output without bothering with the volume settings.

- ① Push [FUNC] then [CALL] to activate the function.
  - "AFMUTE" appears in the display and the audio for both bands is muted.
- ② Push any switch or key to cancel the function.
  - "AFMUTE" disappears from the display.



## 5 BASIC OPERATION

### ■ U by U and V by V functions

The transceiver can receive 2 frequencies simultaneously on either the VHF or UHF band using the U by U function.

① Turn the single band function OFF if it is in use (opposite).

② Push [FUNC] then [(BAND)VV·UU] to turn the U by U function ON or twice to turn the V by V function ON.

- "U" appears in the VHF display.
- Both band frequency displays show UHF frequencies or VHF frequencies while the function is in use.

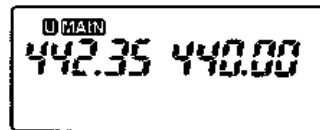
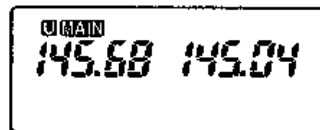

③ Push [FUNC] then [(BAND)VV·UU] once or twice to cancel.

/// The [FUNC] switch remains in effect ("  " appears) for 5 sec. while some keys are pushed. Therefore, pushing [(BAND)VV·UU] (and [FUNC] only once) selects the above functions in sequence.

#### NOTE:

- Memory channels and repeater memory are used for both frequency displays.
- The left frequency display cannot use 5 and 15 kHz tuning steps while in the U by U function.
- Repeater memory cannot be overwritten while it is indicated in one of the band frequency displays.
- The receive frequency of the opposite band display is muted during transmitting.

### ■ Single band function

This function turns the sub band circuit OFF and allows the transceiver to be used as a mono band transceiver. This function is useful to conserve battery power.

① Turn the U by U function OFF if it is in use (opposite).

② Push [FUNC] then [BAND] for 1 sec. to turn the sub band OFF.

- The sub band frequency, etc., disappears.
- The operating band can be changed with [BAND].

③ To turn the sub band ON again, repeat step ② above.

- The sub band frequency, etc., disappears.

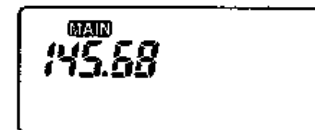

This display shows the UHF band's circuit is turned OFF.

## ■ Transmitting

**CAUTION:** Transmitting without an antenna may damage the transceiver.

**NOTE:** To prevent howling, **avoid** setting the UHF frequency near the 3rd multiple of the VHF frequency.

- ① Select VHF or UHF as the main band for transmitting.
- ② Set the operating frequency.
- ③ Push and hold [PTT] to transmit.
  - The TX indicator lights red.
  - The S/RF indicator shows the output power selection.
  - The sub band can receive while transmitting in the main band depending on the set mode setting (p. 19).
- ④ Speak into the microphone using your normal voice level.
  - Do not** hold the transceiver too close to your mouth or speak too loudly. This may distort the signal.
- ⑤ Release [PTT] to return to receive.

### ◇ Output power selection

Push [H/L] one or more times to select the desired output as illustrated below.

POWER SELECTION	S/RF INDICATOR	OUTPUT POWER (typical; at 13.5 V)	
		VHF	UHF
HIGH	1 0 0 5 9	5.0 W	5.0 W
LOW	LOW	0.5 W	0.5 W
E LOW	E LOW	15 mW	15 mW

### ◇ Automatic power down function

The automatic power down function automatically selects “E Low” (15 mW) as the output power just before the battery becomes exhausted. When this function activates, the battery will be immediately exhausted.

- When using dry cell batteries with the BP-170, you can still transmit for a short time at “E LOW.”
- This function can be turned ON and OFF as illustrated below.

USING SET MODE

#### SETTING THE AUTOMATIC POWER DOWN FUNCTION ON/OFF

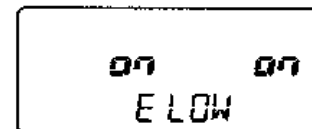

The automatic power down function is ON.

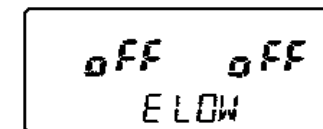

The automatic power down function is OFF.

- ① Push [FUNC] then [SET] to enter set mode.
- ② Push [▽] or [△] until “E LOW” appears as shown above.
- ③ Rotate [DIAL] to turn the automatic power down function ON or OFF.
- ④ Push [CLR] to exit set mode.

## 5 BASIC OPERATION

### ■ Crossband full duplex

The transceiver can receive the sub band frequency while transmitting on the main band. Using this capability, crossband full duplex operation is possible.

When operating crossband full duplex with another station, howling may occur. To prevent this, at least one of the stations should use an optional HS-85 HEADSET or SP-13 EARPHONE.

- ① Turn crossband full duplex ON as described at right.
- ② Set the transmit frequency.
  - Select the transmit band as the main band with [BAND].
  - Set the desired frequency or memory channel.
- ③ Set the receive frequency.
  - Select the receive band as the main band with [BAND].
  - Set the desired frequency or memory channel.
  - Return the main band to the transmit band with [BAND].
- ④ Set the same frequencies, but select your receiving band as the main (transmit) band for the other transceiver.
- ⑤ Push and hold [PTT] to operate in full duplex.
  - Transmitting and receiving activate simultaneously.

### ◇ Crossband full duplex and semi-duplex

The crossband full duplex function can be turned ON/OFF in set mode. When the function is OFF, the sub band audio is muted during transmission.

#### USING SET MODE

#### SELECTING CROSSBAND FULL DUPLEX OR SEMI-DUPLEX

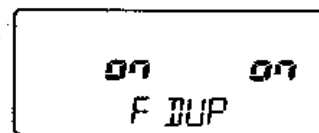

Crossband full duplex is ON.

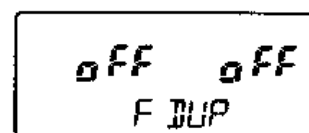

Crossband full duplex is OFF.

- ① Push [FUNC] then [ⓈSET] to enter set mode.
- ② Push [⊕▽] or [⊕△] until "FDUP" appears as shown above.
- ③ Rotate [DIAL] to select crossband full duplex ("on") or semi-duplex ("off").
- ④ Push [ⓈCLR] to exit set mode.

**NOTE:** When transmitting on the main band, the sub band's S-meter does not swing although its receiver circuit functions normally.

## ■ Operation

A repeater amplifies a received signal and retransmits it on a different frequency. When using a repeater, the transmit frequency is shifted from the receive frequency by the offset frequency (p. 21). To speed up operation via a repeater, it is convenient to program repeater information into a memory channel (p. 24).

- ① Select VHF or UHF with [BAND].
- ② Set the receive frequency (repeater output frequency).
- ③ Push [FUNC] then [④DUP] to select -duplex or push [④DUP] again (while " [ ] " appears) to select +duplex.
  - "-DUP" or "DUP" appears to indicate the transmit frequency for minus shift or plus shift, respectively.
  - When the auto repeater function is in use (U.S.A. version only), this selection is not necessary (p. 22).
- ④ Push and hold [PTT] to transmit.
  - The displayed frequency automatically changes to the transmit frequency (repeater input frequency).
  - When the repeater requires a tone, see section at right.
  - The operating condition is automatically programmed into a repeater memory. See p.22 for details.
  - If "o.FF" appears, check the offset frequency (p.21).
- ⑤ Release [PTT] to receive.
- ⑥ Push and hold [MONI] to check whether the other station's transmit signal can be directly received or not.

## ■ Tone information

### SUBAUDIBLE TONES

(Optional for the Eur., Italy and U.K. versions.)

- ① Push [FUNC] then [①T/TSQL] to turn ON the subaudible tone encoder.
  - To set the subaudible tone frequency, see "Subaudible tone" on p. 21.
- ② Push [FUNC] then [①T/TSQL] to turn the subaudible tone encoder OFF.
  - When an optional tone squelch unit is installed, push [①T/TSQL] several times until "T" disappears.

### DTMF TONES

While pushing [PTT], push the desired digit key(s) to transmit DTMF tones.

- The transceiver has 6 DTMF memory channels. See p.38 for details.

### 1750 Hz TONE (Eur., Italy and U.K. versions only)

While pushing [PTT], push and hold [RPT•M] for 1 to 2 sec. to transmit a 1750 Hz tone call signal.

## 6 REPEATER OPERATION

### ■ Subaudible tones

This setting is used for both encoding and decoding subaudible tones. Availability of this function is as follows.

U.S.A. version: both encoding/decoding are standard.

Europe, Italy, U.K. versions: both encoding/decoding are options.

Asia versions: encoding standard, decoding optional.

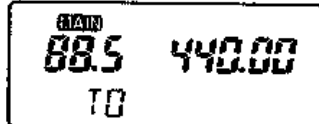

The display shows an 88.5 Hz subaudible tone frequency for the VHF band.

Separate setting for each band

- ① Select VHF or UHF with [BAND].
- ② Select VFO mode with [V/M].
  - Programming is not possible in memory mode.
- ③ Push [FUNC] then [②T FREQ] to enter subaudible tone frequency setting mode.
  - "TO" appears as shown above.
- ④ Rotate [DIAL] to select the desired tone frequency.
- ⑤ Push [ⓐCLR] to exit the subaudible tone frequency setting mode.

#### • Subaudible tone frequency list

67.0	82.5	100.0	123.0	151.4	186.2	233.6	(Unit: Hz)
69.3	85.4	103.5	127.3	156.7	192.8	241.8	
71.9	88.5	107.2	131.8	162.2	203.5	250.3	
74.4	91.5	110.9	136.5	167.9	210.7		
77.0	94.8	114.8	141.3	173.8	218.1		
79.7	97.4	118.8	146.2	179.9	225.7		

### ■ Offset frequency

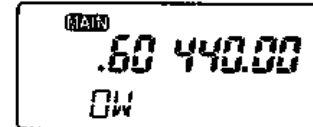

The display shows a 0.6 MHz (600 kHz) offset frequency for the VHF band.

Separate setting for each band

- ① Select VHF or UHF with [BAND].
- ② Select VFO mode with [V/M].
  - Programming is not possible in memory mode.
- ③ Push [FUNC] then [⑤OW FREQ] to enter offset frequency writing mode.
  - "OW" appears as shown above.
- ④ Rotate [DIAL] to select the desired offset frequency.
  - Selectable step increment is the same as the preset tuning step (p. 14).
- ⑤ Push [ⓐCLR] to exit the offset frequency writing mode.

## ■ Repeater memory

This transceiver has a repeater memory in each band which automatically stores the most-recently-used repeater information. The repeater memories are separate from regular memory channels and the call channels.

When transmitting with duplex ON, the following information is automatically programmed into the repeater memory.

- Repeater output frequency (your receiving frequency).
- “-DUP” or “DUP” setting and offset frequency.
- “T” setting and subaudible tone frequency (when used).

When you operate the transceiver in simplex, you can easily call up the repeater memory.

- ① Push [RPT•M] to call up the repeater memory.
  - Programmed repeater information and “RP” appear.
  - Repeater memories are blank before first operating a repeater.
- ② To return to the normal operating mode (VFO or memory mode), push [V/M].

### [REPEATER MEMORY]

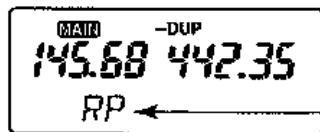

“RP” appears

## ■ Auto repeater function (U.S.A. version only)

The U.S.A. version automatically activates the repeater settings (duplex ON/OFF, duplex direction, tone encoder ON/OFF) when the main band operating frequency falls within or outside of the general repeater output frequency range, respectively. The offset frequency and subaudible tone frequency are not changed by the auto repeater function, reset these frequencies, if desired.

USING SET MODE

Activates for duplex only	Activates for duplex and tone

**SETTING THE AUTO REPEATER FUNCTION ON/OFF**

- ① Push [FUNC] then [ⓈSET] to enter set mode.
- ② Push [Ⓢ▽] or [Ⓢ△] until “AT RPT” appears as shown above.
- ③ Rotate [DIAL] to turn the auto repeater function ON (“1” and “2”) or OFF.
- ④ Push [ⓈCLR] to exit set mode.

## 6 REPEATER OPERATION

### ■ Tone scan

The transceiver can detect the subaudible tone frequency in a received signal. By monitoring a signal that is being transmitted on a repeater input frequency, you can determine the tone frequency of the repeater.

An optional\* UT-93 is necessary to operate tone scan.

\*Standard for the U.S.A. version.

- ① Select the desired band with [BAND].
- ② Select VFO with [V/M].
  - Tone scan cannot be used in memory mode.
- ③ Set the desired frequency to be checked for a tone frequency.
- ④ Push [FUNC] then push [①T/TSQL] several times until "TSQL" appears in the function display.
- ⑤ Push [FUNC] then [③T SCAN] to start the tone scan.
  - To change the scanning direction, rotate the tuning dial.
  - Be sure the pager or code squelch is deactivated in advance (pgs. 39–43).
- ⑥ When the tone frequency is matched, the squelch opens and the tone frequency is programmed into the VFO.
  - The tone scan is turned OFF automatically.

Subaudible tone frequencies flash as they are scanned.

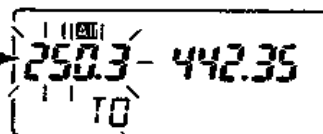

"TO" appears during tone scan

## ■ General description

The transceiver has 46 memory channels (plus 3 pairs of scan edge channels) on each band for storage of often-used frequencies. You can program the following information into each memory channel separately.

At first power ON, memory channels 10 to 46 are not programmed and cannot be selected until they are.

- Operating frequency
- Duplex direction (DUP or -DUP) and its offset frequency (pgs. 20, 21)
- Subaudible tone encoder\* (or optional tone squelch) ON/OFF and its frequency (pgs. 20, 21)
- Skip information (except for the scan edge memory channels)

\*An optional UT-93 TONE SQUELCH UNIT is necessary for the Eur, Italy and U.K. versions.

## MEMORY CHANNEL ARRANGEMENT

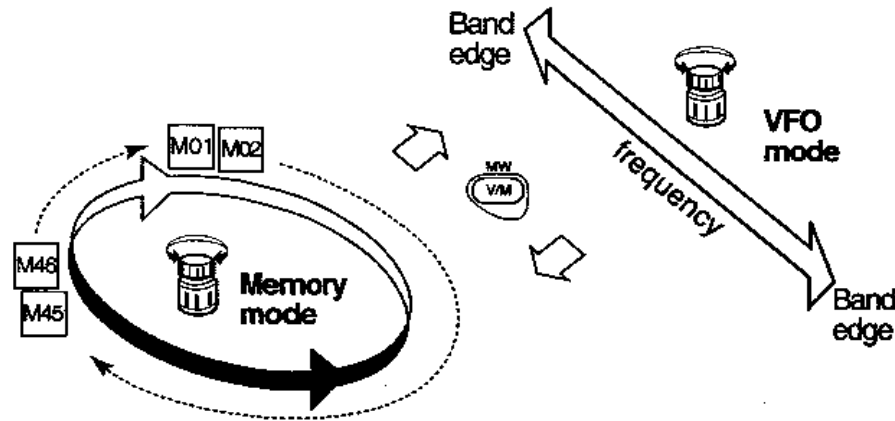

## ■ Memory channel selection

- ① Select VHF or UHF with [BAND].
- ② Push [V/M] to select memory mode.
- ③ Select the desired memory channel.
  - Using the tuning dial:** Rotate [DIAL] to select the desired memory channel.
    - Memory channels 1A/1B to 3A/3B are scan edge channels (p. 31)
  - Using the keypad:** Push numeral keys to enter the memory channel number.
    - Non-programmed channels cannot be selected. Push [ⓂCLR] and re-enter in this case.
    - Scan edge channels cannot be selected in this manner.
  - Using the ∇/Δ or UP/DN keys:** Push [Ⓜ∇]/[ⓂΔ] or [UP]/[DN] to change the memory channel.
    - Pushing [Ⓜ∇]/[ⓂΔ] or [UP]/[DN] for longer than 0.5 sec. will activate memory scan. To stop the scan, push [Ⓜ∇]/[ⓂΔ] or [UP]/[DN] again.
- ④ To return to VFO mode, push [V/M].

**NOTE:** Only programmed memory channels can be selected. See the following pages for programming details.

## 7 MEMORY OPERATION

### ■ Programming after channel confirmation

VFO mode settings, including the set mode contents such as subaudible tone frequency, etc. are programmed into a memory channel.

- ① Select VHF or UHF with [BAND].
- ② Select the memory channel to be programmed:
  - Push [V/M] to select memory mode.
  - Rotate [DIAL] to select the memory channel (only memories already programmed can be selected).
- ③ Set the desired frequency in VFO mode:
  - Push [V/M] to select VFO mode.
  - Set the desired frequency using the keypad or [DIAL].
  - Set other data (e.g. offset frequency, duplex direction, subaudible tone frequency, etc.), if required.
- ④ Push [FUNC] then [(v/m)MW] for 1 sec. to program.
  - If beep tones are turned ON, 3 beeps alert you that the VFO contents, including duplex information, subaudible tone frequency, etc. are programmed.

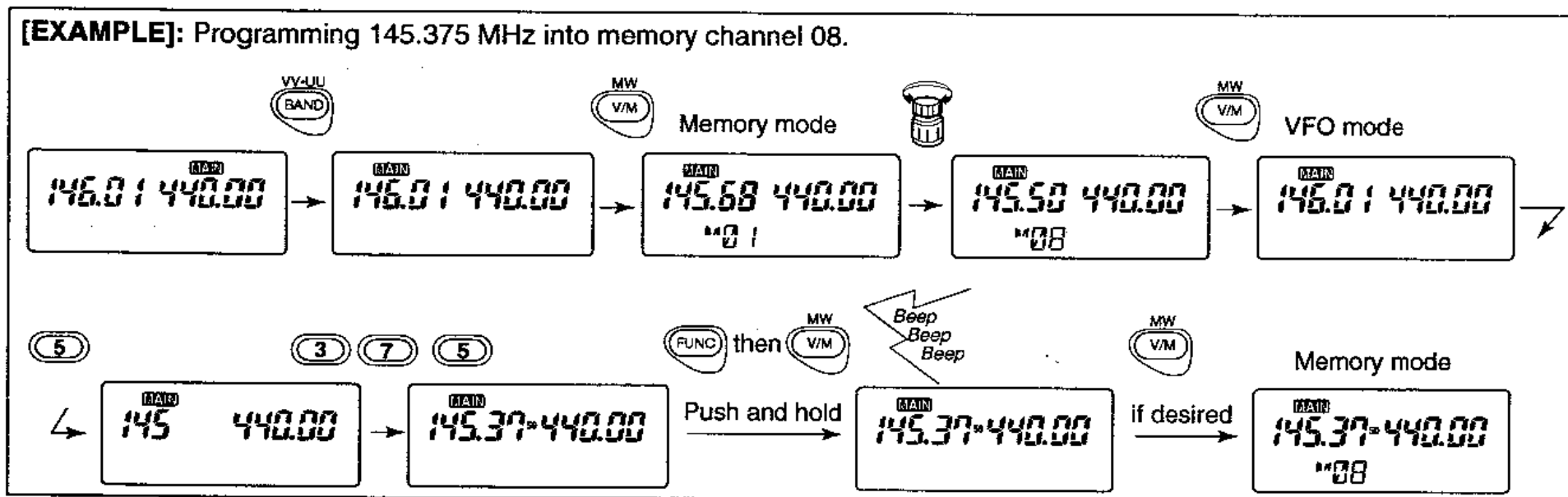

## ■ Programming with channel selection

Any memory channel can be programmed while remaining in VFO mode. This method is convenient for initial programming of memories and rapid programming of several memories in succession.

**NOTE:** Perform the operation between steps ④ and ⑤ within 2 sec. otherwise programming will not be successful.

- ① Select VHF or UHF with [BAND].
- ② Select VFO mode with [V/M].
- ③ Set the desired frequency:
  - ➔ Set the frequency using the keypad or [DIAL].

- ➔ Set other data (e.g. offset frequency, duplex direction, subaudible tone frequency, etc.), if required.
- ④ Push [FUNC] then [(v/m)MW] momentarily to indicate memory channels.
  - Do not hold [MW] for more than 0.5 sec., otherwise the memory channel will overwrite the displayed number.
- ⑤ Rotate [DIAL] to select the desired memory channel.
  - Memories not yet programmed are preceded by "--" in front of the channel number.
- ⑥ Push [(v/m)MW] for 1 sec. to program.

**[EXAMPLE]:** Programming 145.750 MHz into memory channel 40.

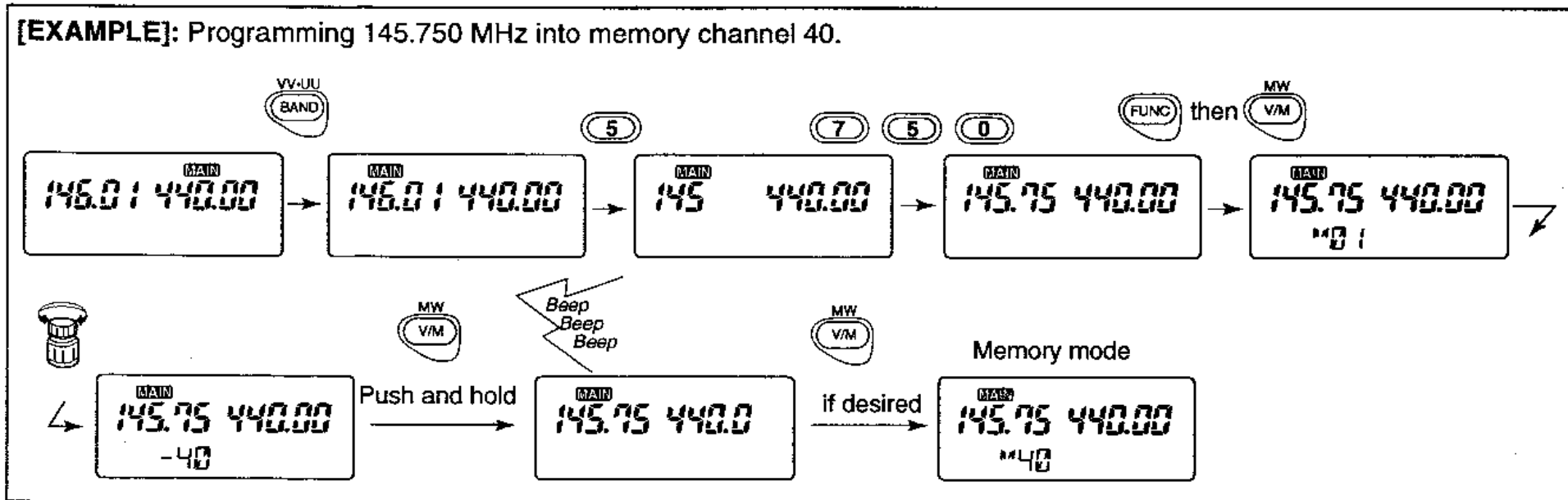

## 7 MEMORY OPERATION

### ■ Memory names

Memory channels can be programmed with names of up to 6 alphanumeric characters in length.

#### ◇ Frequency ↔ Name

To toggle between frequency indication and memory name indication:

- ➔ Push [M·N] when memory mode is selected.
  - "NONAME" appears when a memory channel has not been programmed with a name (see opposite).

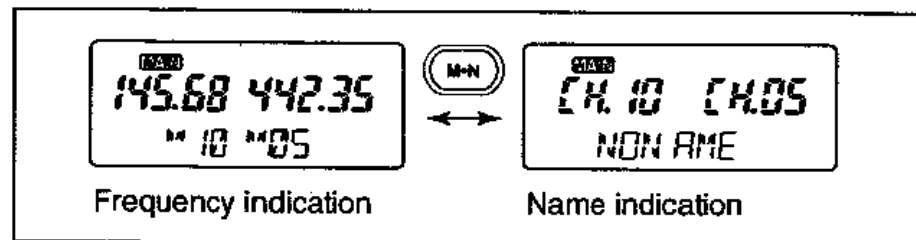

The following characters can be used in names:

- ➔ 0 to 9, A to Z (capitals only), (space), (, ), +, -, =, \*, /, Δ, μ and Σ.

**NOTE:** While using the monitor function, the display shows the frequency even when memory name indication is selected.

- Names cannot be programmed into the call channel.

#### ◇ Programming memory names

To program a name into a memory channel:

- ① Select VHF or UHF with [BAND].
- ② Select the memory channel to be programmed:
  - ➔ Push [V/M] to select memory mode.
  - ➔ Rotate [DIAL] to select the memory channel (only memories already programmed can be selected).
- ③ Push [M·N] to select memory name indication.
- ④ Push [FUNC] then [M·N] to enter memory name writing mode.
  - "-----" appears in place of "NONAME" or the previously programmed memory name.
- ⑤ Rotate [DIAL] to select the first character.
  - [DN]/[UP] or [⊕▽] or [⊕Δ] can be used instead of [DIAL].
- ⑥ Push [M·N] to select the next digit, then repeat step ⑤.
  - When a character is mistakenly input, push [MSG], then input the desired character.
- ⑦ Repeat steps ⑤ and ⑥ until all desired characters have been input; then, push [MONI] to program.
  - When inputting 6 characters, it is not necessary to push [MONI].

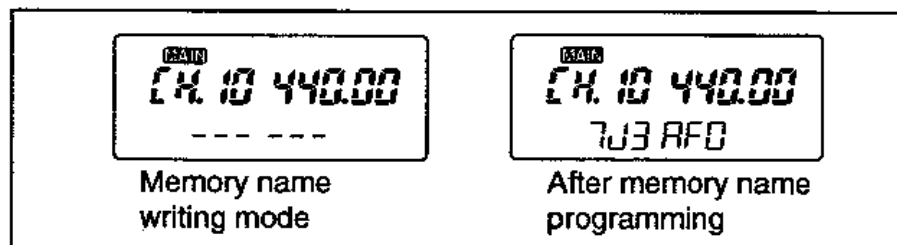

## ■ Transferring memory contents

### ◇ Memory ↔ VFO

This function transfers a memory channel's contents into a VFO. This is useful for searching for signals around a memory channel frequency and for recalling the offset frequency, sub-audible tone frequency, etc.

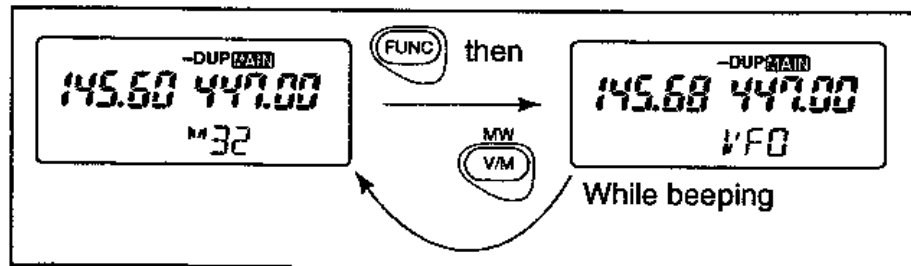

- ① Select VHF or UHF with [BAND].
- ② Select the memory channel to be transferred:
  - Push [V/M] to select memory mode.
  - Rotate [DIAL] to select the memory channel (only memories already programmed can be selected).
- ③ Push [FUNC] then [(v/m)MW] for 1 sec.
  - "VFO" appears for a while, then the display returns to memory channel indication with 3 beeps.

### ◇ Memory ↔ memory

This function transfers a memory channel's contents into a different memory channel. This is useful for editing memory contents.

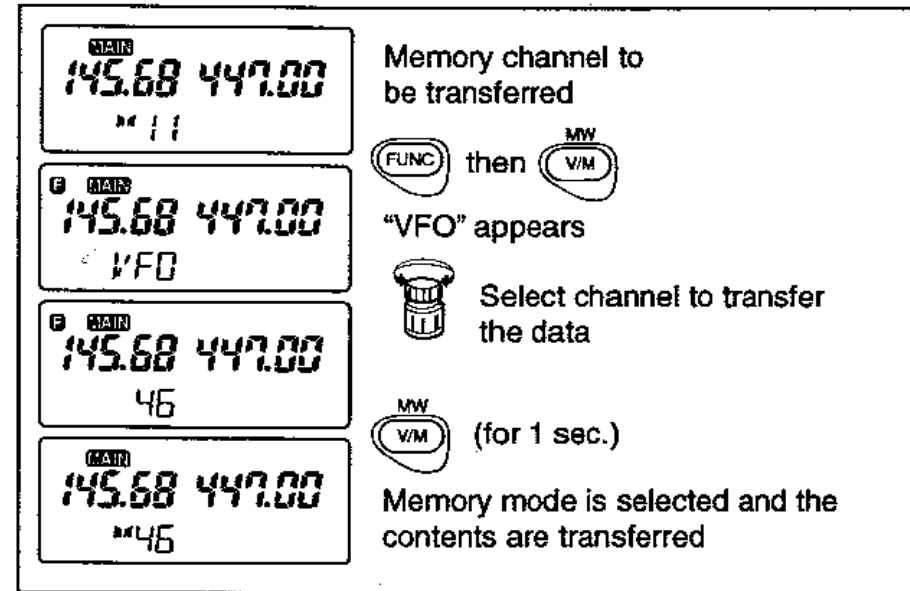

- ① Select VHF or UHF with [BAND].
- ② Select the memory channel to be transferred:
  - Push [V/M] to select memory mode.
  - Rotate [DIAL] to select the memory channel (only memories already programmed can be selected).
- ③ Push [FUNC] then [(v/m)MW] momentarily.
  - "VFO" appears in the display.
- ④ Rotate [DIAL] to select a memory channel to transfer the data.
- ⑤ Push [(v/m)MW] for 1 sec.
  - The contents are transferred and the selected memory appears.

## ■ Accessing a call channel

Each band has an independent call channel to store a most-often-used frequency for quick recall.

- ① Select VHF or UHF with [BAND].
- ② Push [CALL] to select the call channel.
  - “C” or “CALL” appears.
- ③ To return to the previous mode, push [V/M].

## ■ Transferring call channel contents

- ① Select VHF or UHF with [BAND].
- ② Push [CALL] to select the call channel.
  - “C” or “CALL” appears.
- ③ Push [FUNC] then [(v/m)MW] momentarily.
  - “VFO” appears.
- ④ Rotate [DIAL] to select the desired memory channel (or VFO) to transfer the data to.
- ⑤ Push [(v/m)MW] for 1 sec.

## ■ Programming a call channel

As well as an operating frequency, duplex information and subaudible\* tone information (tone encoder or optional tone squelch ON/OFF and its frequency) can be programmed into the call channel.

\*Optional for the Eur., Italy and U.K. versions.

- ① Select VHF or UHF with [BAND].
- ② Set the desired frequency in VFO mode:
  - ➔ Push [V/M] to select VFO mode.
  - ➔ Set the desired frequency using the keypad or [DIAL].
  - ➔ Set other data (e.g. offset frequency, duplex direction, subaudible tone encoder ON/OFF and its frequency), if required.
- ③ Push [FUNC] then [(v/m)MW] momentarily.
  - Do not hold [MW] more than 1 sec., otherwise the contents are programmed into an undesired memory channel.
- ④ Rotate [DIAL] to select the call channel.
  - “CALL” appears to indicate that the call channel is selected.
  - “CALL” is located in front of memory channel 01.
- ⑤ Push [(v/m)MW] for 1 sec.

## ■ Scan types

Each band has 4 scan types and 3 resume conditions providing scanning versatility. Scans on both bands can be operated separately or simultaneously.

### FULL SCAN (p. 31)

Repeatedly scans all frequencies over the entire band.

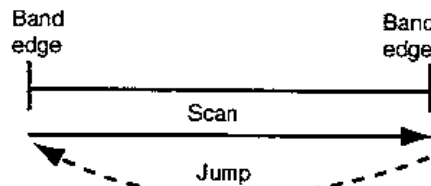

### PROGRAMMED SCAN (p. 31)

Repeatedly scans between two user-programmed frequencies. Used for checking for frequencies within a specified range such as repeater output frequencies, etc.

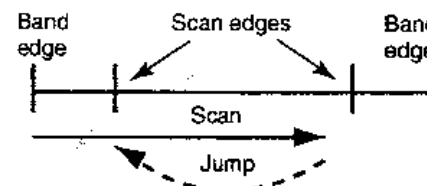

### MEMORY SCAN (p. 32)

Repeatedly scans all memory channels in sequence.

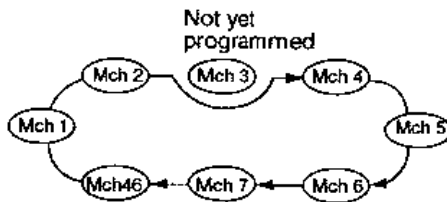

### MEMORY SKIP SCAN (p. 32)

Repeatedly scans memory channels except skip channels. Used for checking often-called channels and bypassing usually busy channels such as repeater frequencies.

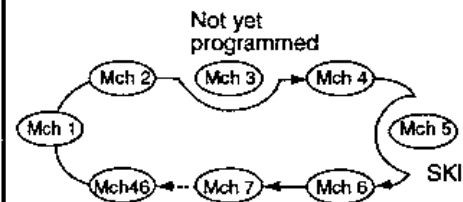

### SCAN RESUME CONDITION (p. 32)

3 resume conditions are available: pause scan and 2 timer scans. When receiving a signal, pause scan pauses until the signal disappears; timer scans pause for 5 or 10 sec.

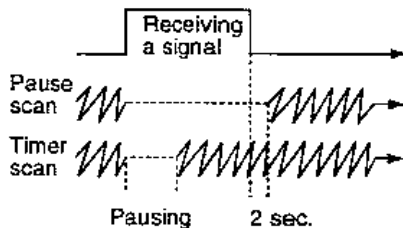

## 9 SCAN OPERATION

### ■ Full scan

- ① Select VHF or UHF with [BAND].
- ② Select VFO mode with [V/M].
- ③ Turn the pager or code squelch function OFF if either is activated with [©PGR/CS].
- ④ Set the selected band's [SQL] to the point where noise is muted.
- ⑤ Push [⊕▽/SCAN] or [⊕△/SCAN] for 1 sec. to start full scan.
  - To change the scanning direction, rotate [DIAL].
  - [DN] or [UP] on the detachable panel can also be used.
- ⑥ To stop the scan, push [⊕▽/SCAN] or [⊕△/SCAN].

### ■ Programmed scan

Scan edge frequencies should be programmed into the scan edge channels in advance. Scan edge channels "1A/1B" to "3A/3B" can be programmed in the same manner as other memory channels. Refer to memory programming (p. 24).

- ① Select VHF or UHF with [BAND].
- ② Select VFO mode with [V/M].
- ③ Select the active scan edge pair in set mode (see right).
- ④ Turn the pager or code squelch function OFF if either is activated with [©PGR/CS].
- ⑤ Set the selected band's [SQL] to the point where noise is muted.
- ⑥ Push [FUNC] then [⊕▽/SCAN] or [⊕△/SCAN] to start programmed scan.

- To change the scanning direction, rotate [DIAL].
  - [DN] or [UP] on the detachable panel can also be used.
- ⑦ To stop the scan, push [⊕▽/SCAN] or [⊕△/SCAN].

### ◇ Programmed scan edge selection

Each band has 3 pairs of scan edges which can be used for programmed scan. When programmed scan is activated, scan operates between one pair of scan edges only. This "designated" pair of scan edges is selected in set mode and is selectable for each band.

#### USING SET MODE

#### SELECTING SCAN EDGES

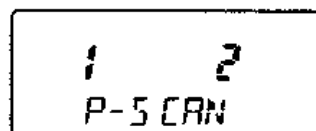

VHF: scan edges 1A/1B  
UHF: scan edges 2A/2B



VHF: scan edges 1A/1B  
UHF: scan edges 3A/3B

- ① Push [FUNC] then [⊕SET] to enter set mode.
- ② Push [⊕▽] or [⊕△] one or more times until "P-SCAN" appears.
- ③ Rotate [DIAL] to designate the desired scan edge pair.
  - The VHF [DIAL] sets the scan edges for the VHF band; the UHF [DIAL] sets the scan edges for the UHF band.
  - "1," "2" and "3" stand for scan edges "1A/1B," "2A/2B" and "3A/3B," respectively.
- ④ Push [⊕CLR] to exit set mode.

## ■ Memory scan

- ① Select VHF or UHF with [BAND].
- ② Push [V/M] to select memory mode.
- ③ Turn the pager or code squelch function OFF if either is activated with [ⓄPGR/CS].
- ④ Set the selected band's [SQL] to the point where noise is muted.
- ⑤ Push [Ⓢ▽/SCAN] or [Ⓢ△/SCAN] for 1 sec. to start the memory scan.
  - To change the scanning direction, rotate [DIAL].
  - [DN] or [UP] on the detachable panel can also be used.
- ⑥ To stop the scan, push [Ⓢ▽/SCAN] or [Ⓢ△/SCAN].

## ■ Memory skip scan

Memory skip scan repeatedly scans programmed memory channels except skip channels. Program the desired channel as a skip channel in advance (p. 33).

- ① Select VHF or UHF with [BAND].
- ② Push [V/M] to select memory mode.
- ③ Turn the pager or code squelch function OFF if either is activated with [ⓄPGR/CS].
- ④ Set the selected band's [SQL] to the point where noise is muted.
- ⑤ Push [FUNC] then [Ⓢ▽/SCAN] or [Ⓢ△/SCAN] to start memory skip scan.
  - To change the scanning direction, rotate [DIAL].
  - [DN] or [UP] on the detachable panel can also be used.
- ⑥ To stop the scan, push [Ⓢ▽/SCAN] or [Ⓢ△/SCAN].

### ◇ Scan resume condition:

- When receiving a signal, scan resumes in one of the following ways:
  - ➔ after pausing 10 sec.
  - ➔ after pausing 5 sec.
  - ➔ after the signal disappears.

- The scan resume condition can be selected in set mode. (p. 33)
- While scanning, rotating [DIAL] changes the scanning direction or skips a paused frequency.

## 9 SCAN OPERATION

### ■ Skip channel setting

Memory channels can be set to be skipped for memory skip scan. This is useful to speedup the memory skip scan interval.

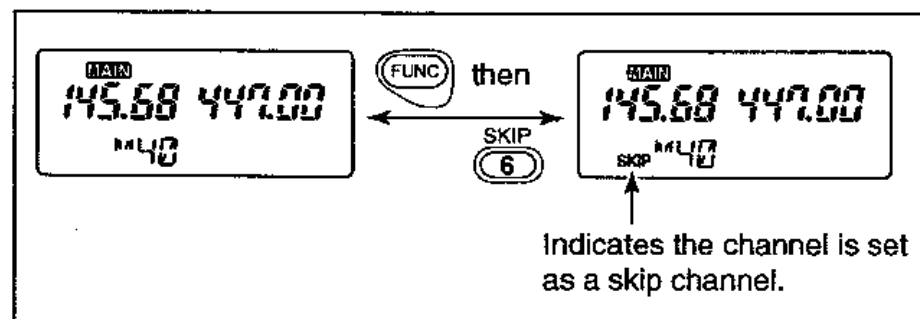

- ① Select the memory channel to be programmed as a skip channel:
  - ➔ Push [V/M] to select memory mode.
  - ➔ Rotate [DIAL] to select the desired memory channel.
- ② Push [FUNC] then [ⓈSKIP] to set the memory channel as a skip channel.
  - "SKIP" appears.
- ③ Repeat step ② to cancel a skip channel.
  - "SKIP" disappears.

### ■ Scan resume condition

USING SET MODE

The resume condition can be selected as a pause or timer scan. The resume condition is used for both scan and priority watch (p. 34)

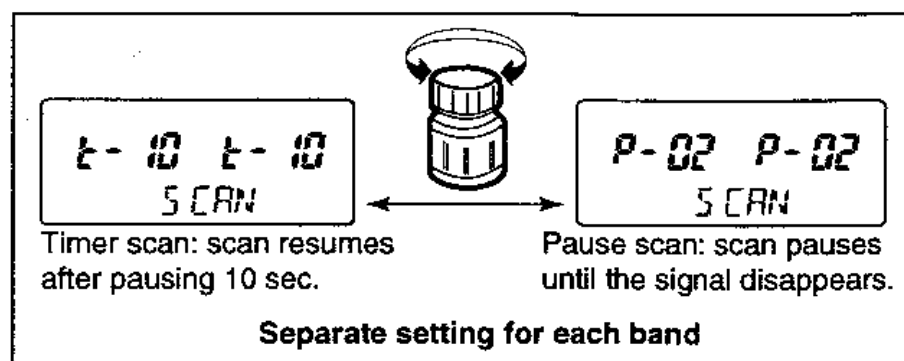

- ① Push [FUNC] then [ⓈSET] to enter set mode.
- ② Push [Ⓢ▽] or [Ⓢ△] one or more times until "SCAN" appears.
- ③ Rotate [DIAL] to set the desired timer.
  - ➔ "t-10": Scan pauses 10 sec. while receiving a signal.
  - ➔ "t-05": Scan pauses 5 sec. while receiving a signal.
  - ➔ "P-02": Scan pauses until the signal disappears and then resumes 2 sec. after that.
- ④ Rotate the other band's [DIAL] to set the other band condition if desired.
- ⑤ Push [ⓈCLR] to exit set mode.

## ■ Priority watch types

The priority watch checks for signals on a memory or call channel every 5 sec. while operating on a VFO frequency. You can transmit on the VFO frequency while the priority watch operates.

When receiving a signal, priority watch pauses according to the set scan resume condition.

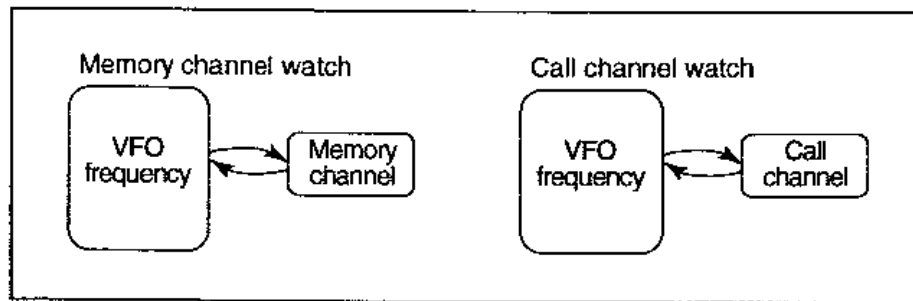

### NOTE:

- Priority watch does not operate when the pager or code squelch function is activated (pgs. 39–43).
- If an optional pocket beep function is activated, the transceiver automatically selects the tone squelch function when priority watch starts.

## ■ Priority watch operation

- ① Select VHF or UHF with [BAND].
- ② Select VFO mode; then, set a frequency.
- ③ Push [V/M] or [CALL] to select a memory channel or the call channel, respectively, as the watching channel.
- ④ Push [FUNC] then [PRIO] to start the watch.
  - The transceiver receives the memory or call channel frequency every 5 sec.
  - While the watch is pausing, pushing [CLR] resumes the watch manually.
- ⑤ Push [CLR] while the display shows the VFO frequency to stop the watch.

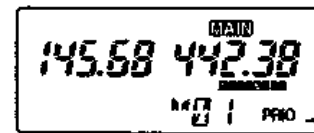

While pausing on a memory channel, "PRIO" flashes.

## ■ Clock operation

### ◇ Setting the clock

AT POWER ON

- ① While pushing [SET] + [CLOCK], push [POWER] to turn power ON and enter the time setting condition.
- ② Rotate the VHF [DIAL] to set the hours (24-hour system).
- ③ Rotate UHF [DIAL] to set the minutes.
- ④ Push [CLR] to set the clock to zero sec., if desired.
- ⑤ Push [PTT] to exit time setting and enter normal function display indication.

### ◇ Displaying the clock

Push [CLOCK] to call up the clock display.

**TIME ERROR:** ± 1 min./week

**NOTE:** The clock is powered by an internal, rechargeable lithium battery when the battery pack is detached or exhausted. If the transceiver is left for 1 week or more without an attached battery pack, the clock is cleared and a different time appears when next using the transceiver. In this case, the clock must be reset.

**[EXAMPLE]:** Setting the clock for 15:45.

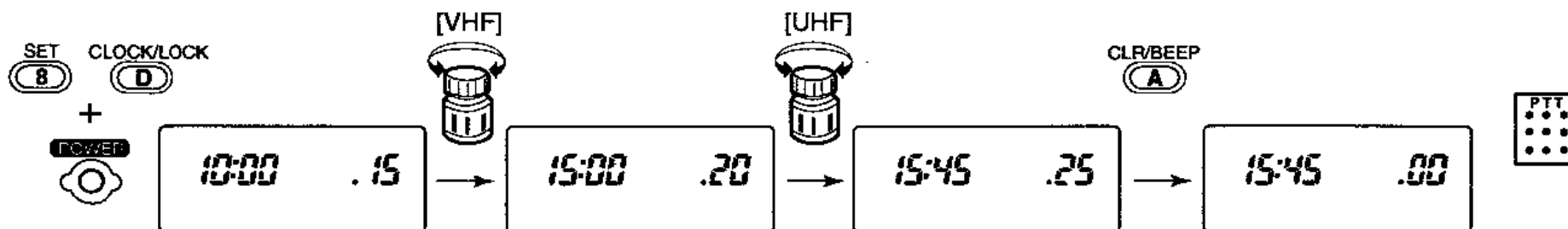

## ■ Timer mode

The transceiver has a built-in 24-hour clock with auto power-off, power-on timer and power-off timer functions.

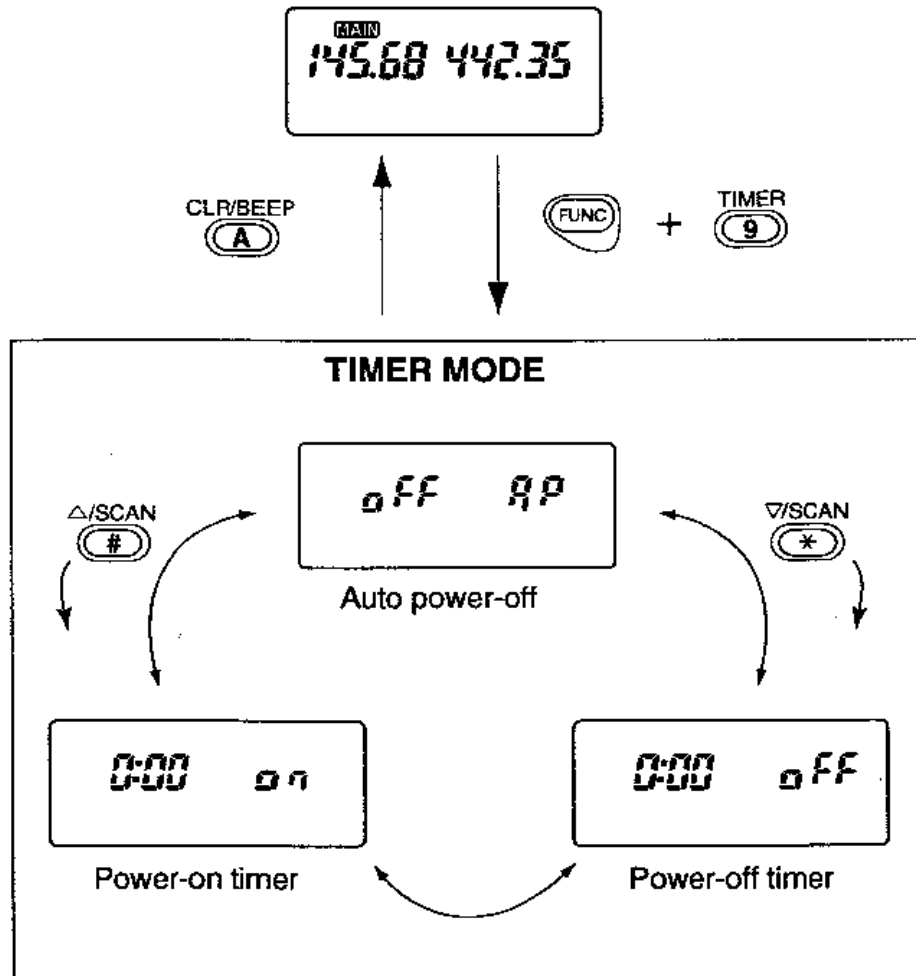

## ■ Auto power-off

The transceiver automatically turns OFF after a selected period in which no switch is pushed.

60 min., 40 min., 20 min. and OFF can be selected. The selected period is retained even when the transceiver is turned OFF by the auto power-off function. To cancel the function, select "off" in step ③ below.

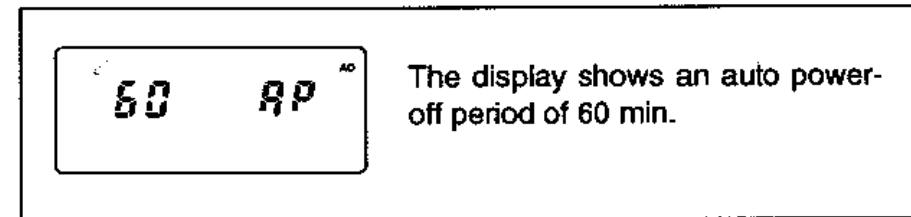

- ① Push [FUNC] then [9TIMER] to enter timer mode.
- ② Push [⊕∇] or [⊕Δ] once or twice to select "AP."
- ③ Rotate [DIAL] to select the auto power-off period or turn the function OFF.
- ④ Push [⊕CLR] to exit timer mode.
  - "AO" appears in the display while the auto power-off function is in use.
- ⑤ When the set period passes, the power is automatically turned OFF, accompanied by 5 beeps.

## ■ Power-on/power-off timers

Use the power-on/off timers for scheduled QSO's and to save battery power, etc.

- ① Push [FUNC] then [ⓉTIMER] to enter timer mode.
- ② Push [Ⓢ▽] or [Ⓢ△] until "on" appears for the power-on timer or "oFF" appears for the power-off timer.
- ③ Push [ⓈCLOCK], then rotate [VHF DIAL] to set the hours and [UHF DIAL] to set the minutes.
  - The clock display appears.
- ④ Push [ⓈCLOCK] again, then rotate [DIAL] to activate the timer.
  - "ON" and Ⓢ appear when the power-on timer is activated.
  - "OFF" and Ⓢ appear when the power-off timer is activated.
- ⑤ Push [ⓈCLR] to exit timer mode.
  - For the power-on timer, turn power OFF.
- ⑥ When the set time arrives, the power is automatically turned ON or OFF.

**NOTE:** The timer ON or OFF setting is cleared once the timer activates. However, the set time is retained for the next operation.

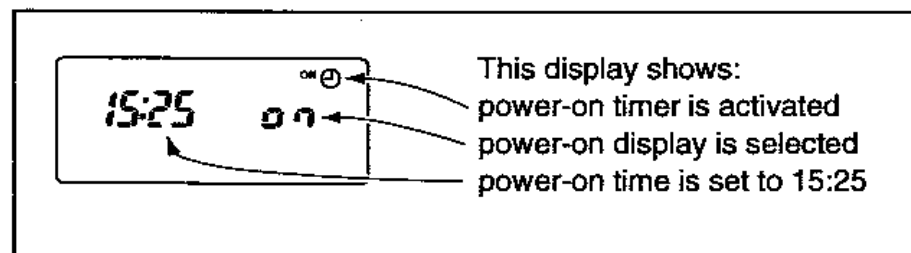

*To cancel the power-on/power-off timer:*

- ① Push [FUNC] then [ⓉTIMER] to enter timer mode.
- ② Push [Ⓢ▽] or [Ⓢ△] until "on" for the power-on timer or "oFF" for the power-off timer appears.
- ③ Rotate [DIAL] to cancel the timer.
  - "on" or "oFF" and Ⓢ disappear when the timer is cancelled.

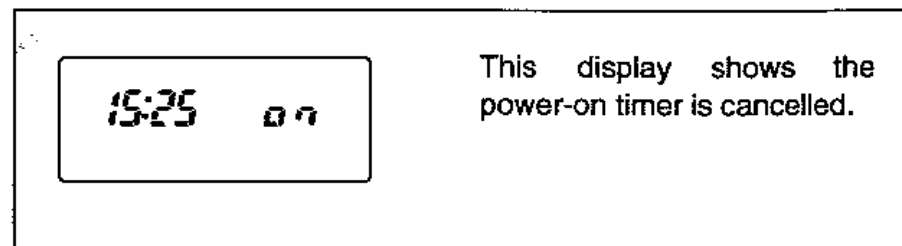

- ④ Push [ⓈCLR] to exit timer mode.

**NOTE:** When setting a timer, be sure that the timer indication (Ⓢ) appears, otherwise the timer will not function even though a time may be programmed.

## ■ Programming a DTMF code

The transceiver has 6 DTMF memory channels (d1 to d6) for storage of often-used DTMF codes of up to 30 digits. The memory channels are for common use on both bands.

- ① Push [FUNC] then [(MONI)DTMF] to enter DTMF memory mode.
  - “dISP” appears.
- ② Rotate [DIAL] to select the desired channel.
- ③ Push [FUNC] then [ⓈSET]; then, rotate [DIAL] to select the 1st digit.
  - “E” stands for “\*” and “F” stands for “#.”
- ④ Push [M•N] to increment digit selection, then rotate [DIAL] to select the next digit.
  - Push [MSG] to decrement digit selection, if desired.
- ⑤ When the desired number of digits have been input, push [(MONI)DTMF] to store them.
- ⑥ Push [PTT] to exit DTMF memory mode.

## ■ Transmitting a DTMF code

### ◇ Using a DTMF memory channel

- ① Push [FUNC] then [(MONI)DTMF] to enter DTMF memory mode.
- ② Rotate [DIAL] to select the desired channel.
- ③ Push [PTT] to exit DTMF memory mode.
- ④ While pushing [PTT], push [MONI] to transmit the selected DTMF code.

**NOTE:** Push [MONI] while in DTMF memory mode to monitor a DTMF channel without transmitting it.

### ◇ DTMF speed

When slow DTMF transmission speeds are required, the transceiver’s rate of DTMF transmission can be adjusted in set mode. Refer to p. 51 for details.

**[EXAMPLE]:** Programming “21ABC3” into DTMF memory “d3”.

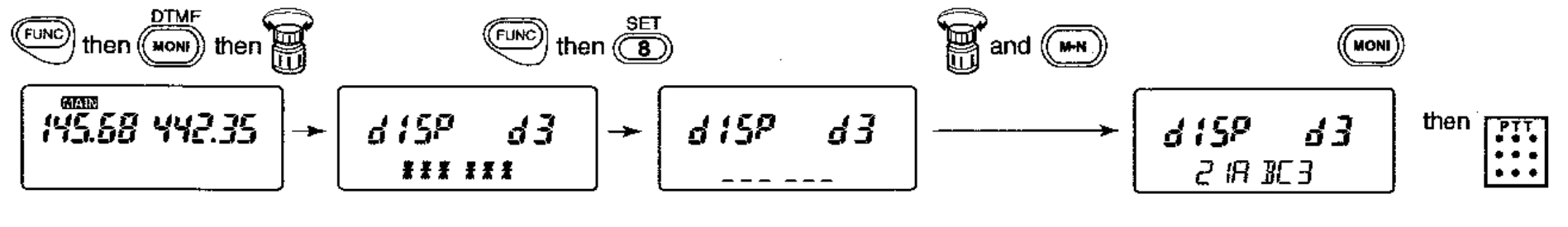

## ■ Pager function

This function uses DTMF codes for paging and can be used as a "message pager" to inform you of a caller's identity even if you leave the transceiver temporarily unattended.

Personal calls and group calls are available with the pager function. Personal calls use the receiving parties' ID code for calling. The receiving parties' display shows your ID code and other stations in the party know that you called. You can also call all stations in your group using the group call.

To use the pager function in your group, all stations need the pager function.

During pager operation, the power saver duty cycle becomes 1:1 if the power saver is activated.

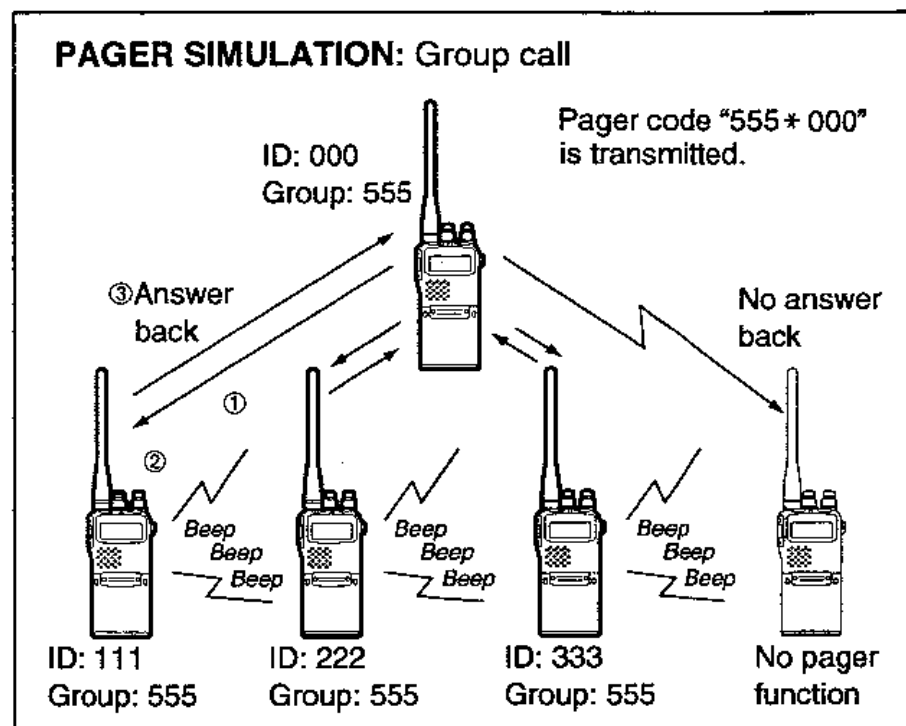
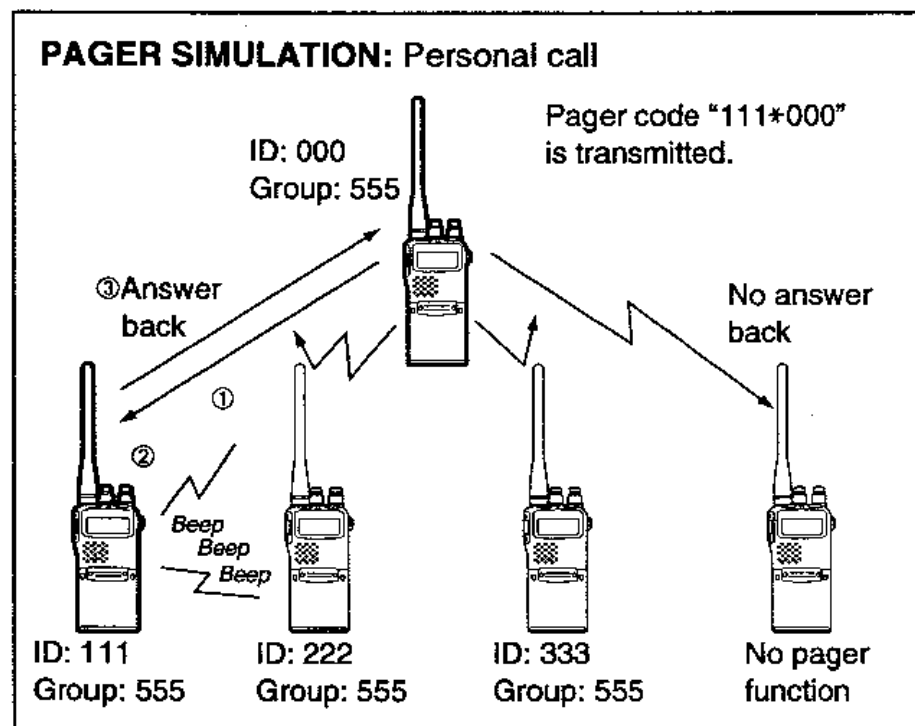

## ■ Code channel

### • Before programming

The pager and code squelch functions require ID codes and a group code. These codes are 3-digit DTMF codes and must be written into the code channels before operation.

### • Code channel assignment

ID or group code	Code channel number	"Receive accept" or "Receive inhibit"
Your ID code	C0	"Receive accept" only.
Other parties' ID code	C1–C5	"Receive inhibit" should be programmed in each channel.
Group code	One of C1–C5	"Receive accept" must be programmed.
Memory space*	CP	"Receive inhibit" only.

\* Channel CP automatically memorizes an ID code when receiving a pager call. The contents in channel CP cannot be changed manually.

### **"RECEIVE ACCEPT" OR "RECEIVE INHIBIT"**

Code channels C1–C5 should be effectively programmed as "Receive accept" or "Receive inhibit."

- "Receive accept" ("SKIP" indicator does not appear) accepts pager calls when the transceiver receives a signal with a code the same as that in the code channel.
- "Receive inhibit" ("SKIP" indicator appears) rejects calls even when the transceiver receives a signal with a code the same as that in the code channel.

For example, the code channel that stores the group code should be programmed as "Receive accept." If the channel is programmed as "Receive inhibit," you cannot receive group calls.

The code channels that store other parties' ID codes for a transmit code should be programmed as "Receive inhibit." If the channels are programmed as "Receive accept," personal calls for parties other than yours will be received.

## ■ Code programming

- ① Select VHF or UHF with [BAND].
  - Each band has separate code channels.
- ② Push [FUNC] then [ⓈCODE] to select the code channel setting display.
- ③ Rotate [DIAL] to select the desired code channel, C0–C5.
  - Code channel C0 cannot be used for programming.
- ④ Push the numeral keys to input the desired 3-digit code.
  - Digits are automatically stored once the 3rd digit has been entered.
  - When a digit is mistakenly input, push [ⓈCLR] and enter the desired code from the beginning.
- ⑤ Push [FUNC] then [ⓈSKIP] to set the channel for “receive inhibit” or “receive accept.”
  - When “receive inhibit” is set, “SKIP” appears.
  - Code channel C0 cannot be set as “receive inhibit.”
  - See the previous page for “receive accept” and “receive inhibit” details.
- ⑥ Push [PTT] to exit the setting display.

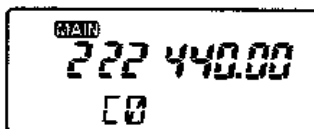

This display shows code channel C0 is programmed for 222.

## ■ Pager operation

### ◇ Calling a specific station

- ① Select VHF or UHF with [BAND].
  - The pager function can be used on one band only.
- ② Set the operating frequency.
- ③ Push [ⓈPGR/CS] once or twice to turn the pager function ON.
  - “P” appears in place of the 100 MHz digit.
  - An optional tone squelch can be used together with the pager function.
- ④ Select the desired code channel:
  - ➔ Push [FUNC] then [ⓈCODE].
  - ➔ Rotate [DIAL] to select the channel.
  - ➔ Push [PTT] to exit the setting display.
- ⑤ Push [PTT] to transmit the pager code.
- ⑥ Wait for an answer back.
  - When the transceiver receives an answer back code, the function display shows the other parties’ ID or group code.
- ⑦ After confirming a connection, push [ⓈCLR] to display the operating frequency.
  - Do not push any digit keys while code channels C0 to C5 are displayed, or code channel contents are changed.
- ⑧ Push [ⓈPGR/CS] once to select the code squelch or twice to select the non-selective calling system.

## ◆ Waiting for a call from a specific station

- ① Select VHF or UHF with [BAND].
  - The pager function can be used on one band only.
- ② Set the operating frequency.
- ③ Push [©PGR/CS] once or twice to turn the pager function ON.
  - "P" appears in place of the 100 MHz digit.
  - An optional tone squelch can be used together with the pager function.
- ④ Wait for a call.
  - When receiving a call, the caller's ID or group code appears and the receiving time flashes as shown at right.
  - Push [FUNC] to display the code channel (time indication disappears).
  - **DO NOT** push any digit keys while code channels C0 to C5 are displayed, or code channel contents are changed.
- ⑤ Push [PTT] to send an answer back call and display the operating frequency.
- ⑥ Push [©PGR/CS] once to select code squelch operation or twice to select the non-selective calling system.

### PERSONAL CALL

This display appears when you are called with your ID code and the calling station's ID code is 386.

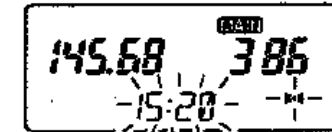

Receiving time flashes

### GROUP CALL

This display appears when you are called with the group code, 123, 123 has been programmed into code channel C5, and you respond by pushing [FUNC].

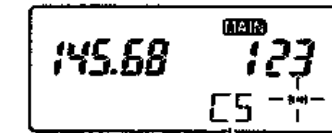

Code channel

### ERROR INFORMATION

When the transceiver receives an incomplete signal, "E" appears.

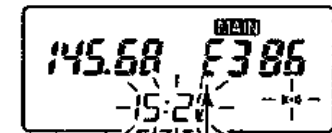

"E" appears

## ■ Code squelch operation

Code squelch provides communication with silent standby since you will only receive calls from stations which know your ID or group code.

Code squelch transmits a 3-digit code prior to voice transmission in order to open the receiving station's code squelch.

During code squelch operation, the power saver duty cycle becomes 1 : 1 if the power saver is activated.

### CODE SQUELCH SIMULATION: ID code

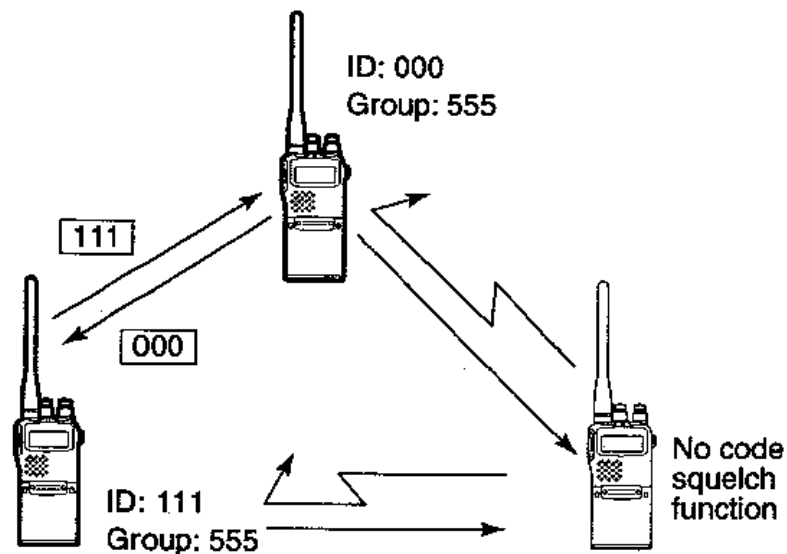

- ① Select VHF or UHF with [BAND].
  - The code squelch can be used on one band only.
- ② Set the operating frequency.
- ③ Push [ⓄPGR/CS] once or twice to turn the code squelch ON.
  - "C" appears in place of the 100 MHz digit.
  - An optional tone squelch can be used together with the code squelch. (p. 48)
- ④ Select the desired code channel:
  - ➔ Push [FUNC] then [ⓄCODE].
  - ➔ Rotate [DIAL] to select the channel.
  - ➔ Push [PTT] to exit the setting display.
- ⑤ Operate the transceiver in the normal way (push [PTT] to transmit; release [PTT] to receive).
  - Prior to voice transmission, a 3-digit transmit code is sent each time [PTT] is pushed in order to open the receiving station's code squelch.
- ⑥ To cancel the code squelch, push [ⓄPGR/CS].
  - "C" disappears and the 100 MHz digit returns to the display.

## ■ Message function

### ◇ What is the message function?

This transceiver has the capability to send and receive 6-digit alphanumeric “messages” during pager or code squelch operation. These messages are shared between bands with 10 separate memories for storage of pre-programmed transmit messages and 10 separate memories for storage of received messages.

### ◇ Calling up a receive message memory

Received messages are automatically stored in one of the 10 receive message memories.

- ① Push [MSG] once to select a receive message memory.
  - One of “r0” to “r9” appears.
- ② Rotate [DIAL] to select the desired memory.
  - The [▽]/[△] or [UP]/[DN] keys can also be used.
- ③ Push [CLR] to exit the receive message mode.

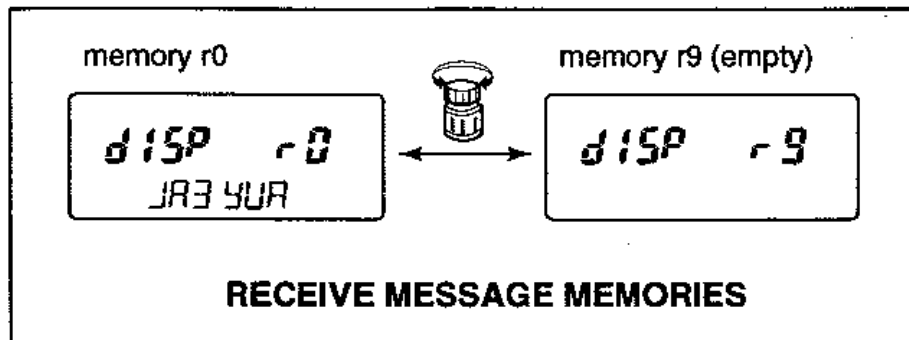

### ◇ Receiving a message

- ① Select VHF or UHF with [BAND].
- ② Select VFO mode; then, set a frequency.
- ③ Set the transceiver for pager or code squelch operation.
  - Remember that ID code programming, etc. for each transceiver in the group is necessary.
- ④ Push [FUNC] then [MSG].
  - “MSG” appears.
- ⑤ When receiving a signal with a message, the message is programmed into receive message channel “r1” and indicated.
  - The previous message is shifted to “r0,” “r9” and so on.
- ⑥ To confirm the previous message rotate [DIAL] to select the appropriate receive message memory.
- ⑦ Push [CLR] to return to frequency indication.

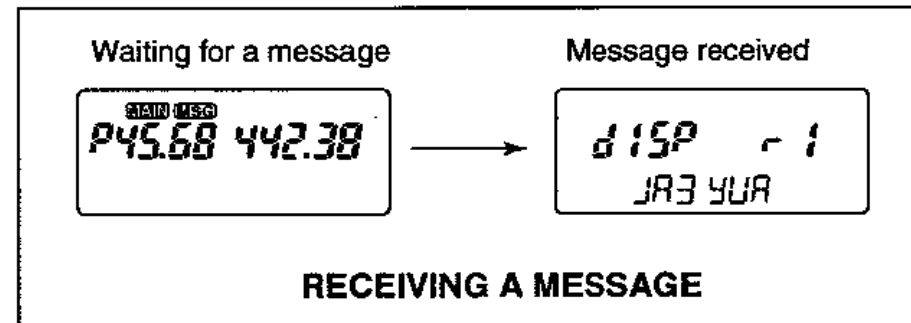

# 13 PAGER AND CODE SQUELCH

## ◇ Transmitting a message

Messages can be either be transmitted manually or automatically (from pre-programmed transmit message memories).

- ① Select VHF or UHF with [BAND].
- ② Select VFO mode; then, set a frequency.
- ③ Set the transceiver for pager or code squelch operation.
- ④ Push [FUNC] then [MSG].
  - “MSG” appears.

### To transmit a pre-programmed message memory:

- ⑤ Push and hold [PTT].
  - The pager or code squelch code is transmitted.
- ⑥ While continuing to push [PTT], push [MSG], then push the corresponding digit key for the transmit message memory.
  - “0” to “9” correspond to transmit message memories “t0” to “t9,” respectively.

### To transmit a message manually:

Use manual transmission for instant transmission of simple messages, such as “number only” messages.

- ⑤ Push and hold [PTT].
  - The pager or code squelch code is transmitted.
- ⑥ While continuing to push [PTT], push [#], then push the corresponding digit keys for the desired message.
  - Refer to the table at right for details.
- ⑦ When the desired message has been input, push [#] to signal the end of the message, then release [PTT].

**[EXAMPLE]:** To send “CU\_AGN”

# 2 C 8 B 1 C 2 A 4 A 6 B #  
 C U space A G N

## ◇ Message characters

The following table lists characters available for messages and their keypad equivalents for manual transmission.

0	[0]	G	[4] + [A]	W	[9] + [A]
1	[1]	H	[4] + [B]	X	[9] + [B]
2	[2]	I	[4] + [C]	Y	[9] + [C]
3	[3]	J	[5] + [A]	Z	[1] + [B]
4	[4]	K	[5] + [B]	(space)	[1] + [C]
5	[5]	L	[5] + [C]	{	[0] + [A]
6	[6]	M	[6] + [A]	}	[0] + [B]
7	[7]	N	[6] + [B]	+	[0] + [C]
8	[8]	O	[6] + [C]	--	[1] + [D]
9	[9]	P	[7] + [A]	=	[2] + [D]
R	[2] + [A]	Q	[1] + [A]	*	[3] + [D]
S	[2] + [B]	R	[7] + [B]	/	[4] + [D]
L	[2] + [C]	S	[7] + [C]	^	[5] + [D]
T	[3] + [A]	T	[8] + [A]	u	[6] + [D]
E	[3] + [B]	U	[8] + [B]	z	[7] + [D]
F	[3] + [C]	V	[8] + [C]	!	[8] + [D]

## ◇ Programming a message for transmit

- ① Push [MSG] 2 times to select a transmit message memory
  - One of "t0" to "t9" appears.
- ② Rotate [DIAL] to select the desired memory.
  - The [▽]/[△] or [UP]/[DN] keys can also be used.
- ③ Push [FUNC] then [SET] to enter message writing mode.
  - "-----" appears.
- ④ Rotate [DIAL] to select the first character.
  - See p. 45 for a list of characters that can be input.
- ⑤ Push [M·N] to select the next digit for input.
  - [MSG] deletes the previous character.
- ⑥ Repeat steps ④ and ⑤ until the desired message is input.
  - 6 characters is the maximum for a message.
- ⑦ Push [M·N] to complete the programming.
  - Push [MONI] when your message is less than 6 digits.
- ⑧ Push [CLR] to exit the message memory.

**NOTE:** Message memory channel t0 is used for the opening message at power ON and "ICOM" is programmed as the default setting.

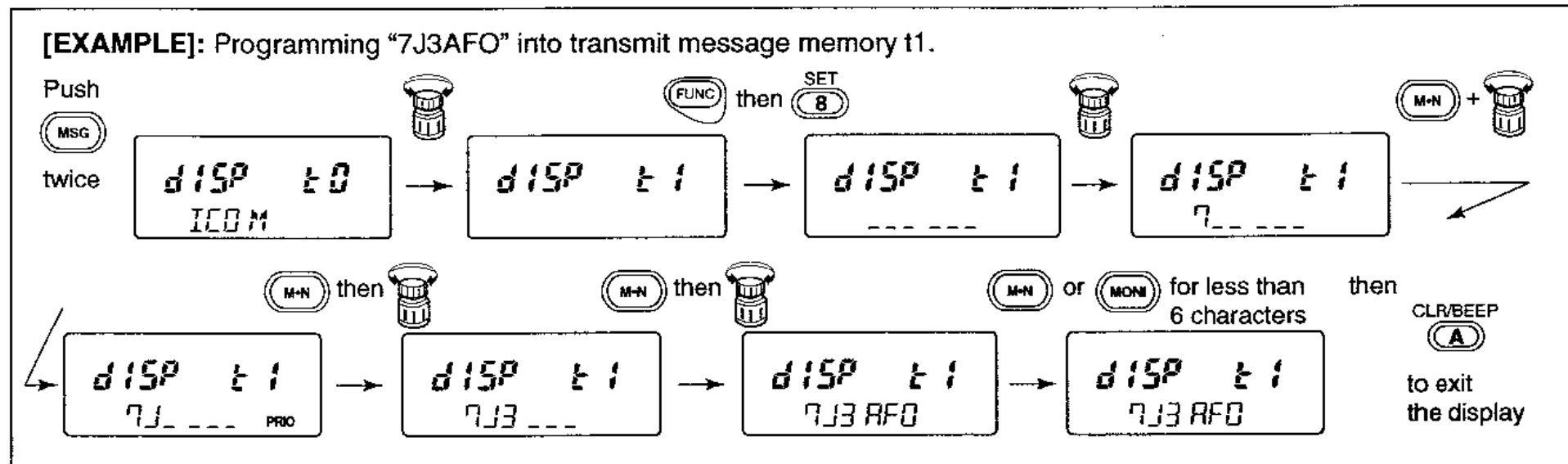

# 14 POCKET BEEP AND TONE SQUELCH

## ■ Optional UT-93 installation

An optional UT-93 TONE SQUELCH UNIT is available for this transceiver. The UT-93 provides tone scan, tone squelch and pocket beep functions.

/// The UT-93 is already built-in to the the U.S.A. version.

- ① Turn power OFF, then remove the battery pack and/or DC power cable.
- ② Unscrew the 6 screws as shown below.

- ③ Carefully separate the front and rear panels as shown below.
- ④ Plug in the UT-93 as shown below.

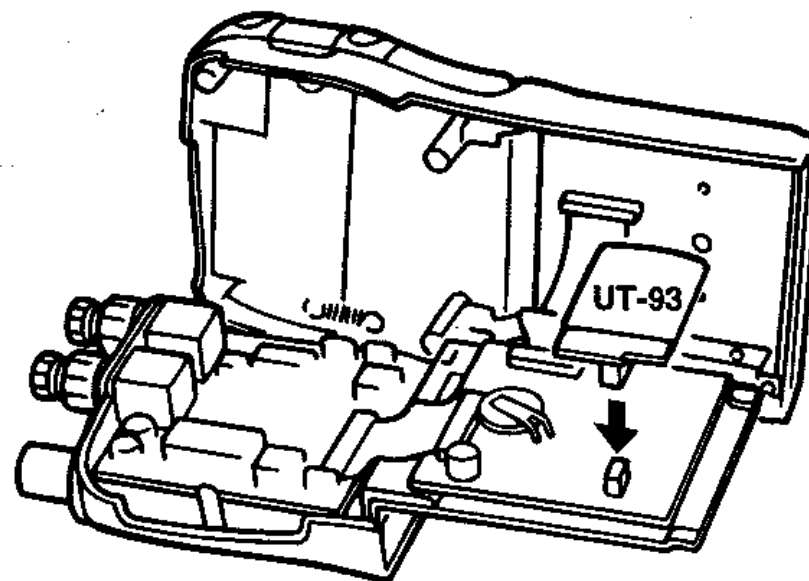

- ⑤ Reassemble the front and rear panels; then, replace the 6 screws removed in step ②.
  - **DO NOT** pinch the ribbon cable.

## ■ Pocket beep operation

This function uses subaudible tones for calling and can be used as a “common pager” to inform you that someone has called while you were away from the transceiver.

### ◇ Waiting for a call from a specific station

- ① Select VHF or UHF with [BAND].
- ② Set the operating frequency.
- ③ Push [FUNC] then [②T FREQ], then rotate [DIAL] to select a subaudible tone frequency.
  - Tone frequency setting is available in VFO mode only. However, pocket beep operation can be performed in memory mode.
  - See p.21 for a list of available frequencies.
- ④ Push [FUNC] then push [①T/TSQL] several times until “T SQL (••)” appears in the function display.
  - Turn OFF the pager or code squelch to activate the pocket beep (pgs.39–43). The pocket beep cannot be used in combination with the pager or code squelch.
- ⑤ When a signal with the correct tone is received, the transceiver emits beep tones for 30 sec. and flashes “T SQL (••).”
- ⑥ Push [PTT] to answer or push [ⒶCLR] to stop the beeps and flashing.
  - Tone squelch is automatically selected.

### ◇ Calling a waiting station using pocket beep

A subaudible tone matched with the station’s tone frequency is necessary. Use the tone squelch at right or a subaudible tone encoder.

## ■ Tone squelch operation

The tone squelch opens only when receiving a signal with the same pre-programmed subaudible tone. You can silently wait for a call from group members using the same tone.

- ① Select VHF or UHF with [BAND].
- ② Set the operating frequency.
- ③ Push [FUNC] then [②T FREQ], then rotate [DIAL] to select a subaudible tone frequency.
  - Tone frequency setting is available in VFO mode only. However, tone squelch operation can be performed in memory mode.
  - See p.21 for a list of available frequencies.
- ④ Push [FUNC] then push [①T/TSQL] several times until “T SQL” appears in the function display.
  - The code squelch can be used together with the tone squelch. (p.43)
- ⑤ When the received signal includes the correct tone, the squelch opens and the signal can be heard.
  - When the received signal includes an incorrect tone, the squelch does not open—only the receive indicator lights green.
  - To open the main band squelch manually, push and hold [MONI].
- ⑥ Operate the transceiver in the normal way (push [PTT] to transmit; release [PTT] to receive).
- ⑦ To cancel the tone squelch, push [FUNC] then [①T/TSQL].
  - “TSQL” disappears from the display.

# 15 OTHER FUNCTIONS

## ■ Power saver

USING SET MODE

The power saver function reduces the current drain to conserve battery power. The power saver duty cycle can be set to 1:4, 1:16 or OFF. Setting it to 1:16 conserves the most power. For packet operation, the power saver should be turned OFF to receive reliable packet data.

- ① Push [FUNC] then [ⓈSET] to enter set mode.
- ② Push [Ⓢ▽] or [Ⓢ△] until "P-SAVE" appears as shown at right.
- ③ Rotate [DIAL] to select the desired duty cycle or to turn the function OFF.
- ④ Push [ⓈCLR] to exit set mode.

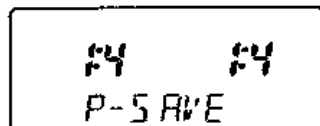

1:4 1:4  
P-SAVE

Standby: 125 msec.  
Circuit off: 500 msec.

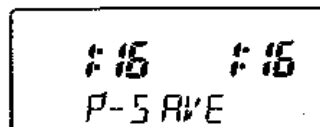

1:16 1:16  
P-SAVE

Standby: 125 msec.  
Circuit off: 2 sec.

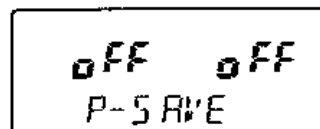

OFF OFF  
P-SAVE

Power saver is OFF.

**NOTE:** When the duty cycle is set to 1:16, signals may be clipped up to a 2 sec. maximum.

## ■ Battery voltage indication

The transceiver has a battery capacity indicator so that you can monitor the connected batteries' voltage level. This function is designed to show dry cell battery consumption in the BP-170 BATTERY CASE. When using a Ni-Cd battery pack, voltage is measured; however, for practical purposes, the indicated value is not useful. This is because once the voltage begins to decrease, it will decrease rapidly as a result of the Ni-Cd battery characteristics.

- ① Push [FUNC] then [ⓈBATT] to indicate the current voltage.
  - A value between 4.5 and 15.5 in 0.5 V steps is indicated in the display.
- ② When the indicator shows "LOW V," the dry cell batteries in the BP-170 may not activate the transmitter circuitry.



MAIN  
145.58 447.00  
LOW V

**NOTE:** The battery indication is only for your reference and may not be accurate.

## ■ LCD lighting

For easy operation at nighttime, the transceiver has an LCD (Liquid Crystal Display) and keypad lighting function with a 5 sec. timer.

### ◇ 5 sec. timer

- ① Push [LIGHT] to turn the lighting ON.
- ② The lighting will automatically turn OFF when no switches or [DIAL]'s have been operated for 5 sec.
- ③ To turn the lighting OFF manually, push [LIGHT] again.

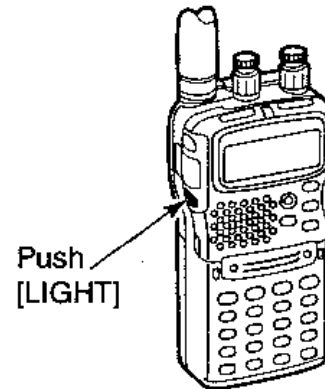

### ◇ Continuous lighting

Push [FUNC] then [LIGHT] for continuous lighting.

- Push [LIGHT] to turn the lighting OFF.

**NOTE:** Continuous lighting remains activated even when the power is turned OFF and ON again.

### ◇ Lighting selection

USING SET MODE

[LIGHT] can be set to backlight the function display and all switches; or, to backlight the detachable panel only.

- ① Push [FUNC] then [ⓈSET] to enter set mode.
- ② Push [Ⓢ▽] or [Ⓢ△] one or more times until "LIGHT" appears as shown opposite.
- ③ Rotate the [DIAL] to set ("ALL") or ("dISP").
- ④ Push [ⓈCLR] to exit set mode.

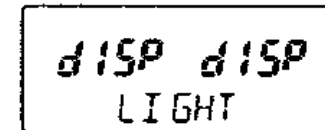

This display shows the backlighting set for the detachable panel only.

## ■ LCD contrast

USING SET MODE

The LCD (Liquid Crystal Display) contrast can be selected from 1 of 4 levels. Select a contrast which gives the best readability for the ambient light conditions.

- ① Push [FUNC] then [ⓈSET] to enter set mode.
- ② Push [Ⓢ▽] or [Ⓢ△] one or more times until "LCD" appears as shown opposite.
- ③ Rotate [DIAL] to set the desired contrast; "1" is lowest and "4" is highest.
- ④ Push [ⓈCLR] to exit set mode.



This display shows the contrast set for the highest level, "4."

## 15 OTHER FUNCTIONS

### ■ PTT lock function USING SET MODE

The PTT lock function locks the PTT switch electronically to prevent accidental transmission.

- ① Push [FUNC] then [ⓈSET] to enter set mode.
- ② Push [⊕▽] or [⊕Δ] one or more times until "PTT LK" appears as shown.
- ③ Rotate [DIAL] to turn the PTT lock function ON ("on") or OFF ("oFF").
- ④ Push [ⓈCLR] to exit set mode.

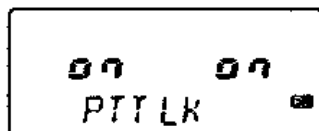

### ■ External speaker selector USING SET MODE

When an external speaker is connected, audio for each band can be selected to external equipment or to the internal speaker.

- ① Push [FUNC] then [ⓈSET] to enter set mode.
- ② Push [⊕▽] or [⊕Δ] one or more times until "SPEAK" appears.
- ③ Rotate either [DIAL] to set each band's audio for either external equipment ("out") or for the internal speaker ("in").
- ④ Push [ⓈCLR] to exit set mode.

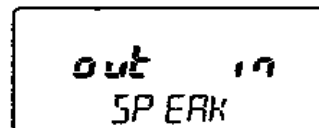

### ■ Volume switch USING SET MODE

The volume switch action can be set to 1 of 3 settings: "HoLd" (switch action is "sticky"), "PUSH" (switch must be pushed and held) and "H-5" (switch remains activated for 5 sec.).

- ① Push [FUNC] then [ⓈSET] to enter set mode.
- ② Push [⊕▽] or [⊕Δ] one or more times until "VOLUME" appears.
- ③ Rotate [DIAL] to set the desired switch action.
- ④ Push [ⓈCLR] to exit set mode.

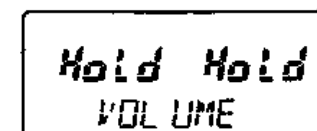

### ■ DTMF speed USING SET MODE

The sending speed of the DTMF memory can be selected from 4 speeds to suit your needs. This setting does not affect pager and code squelch operation.

- ① Push [FUNC] then [ⓈSET] to enter set mode.
- ② Push [⊕▽] or [⊕Δ] one or more times until "DTMF" appears.
- ③ Rotate [DIAL] to set the desired speed.
  - 100 msec. (5 cps), 200 msec. (2.5 cps), 300 msec. (1.6 cps) and 500 msec. (1 cps) are available. (cps = characters/second)
- ④ Push [ⓈCLR] to exit set mode.

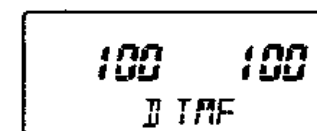

## ■ Optional HM-75A functions

When using an optional HM-75A with the transceiver, the switches on the HM-75A function as follows:

### ① A SWITCH

Toggles the main band between VHF and UHF.

### ② B SWITCH

Changes mode between VFO and memory.

### ③ Δ/∇ SWITCH

➔ Change the frequency in the selected tuning steps in VFO mode.

➔ Change memory channel in memory mode.

➔ Start full scan or memory scan when pushed for 1 sec.

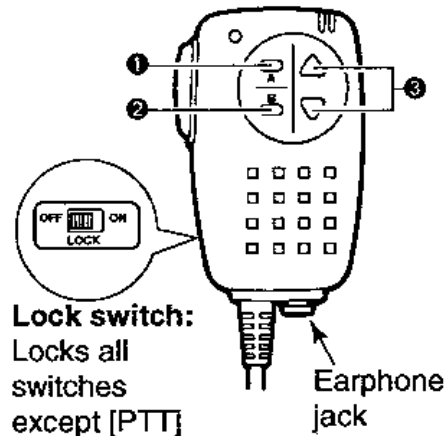

**CAUTION:** When connecting the HM-75A to the transceiver, make sure that power to the transceiver is turned OFF, otherwise the CPU may malfunction.

## ■ All reset

AT POWER ON

Reset the CPU before operating for the first time, or when the internal CPU malfunctions.

- ① Turn power OFF.
- ② While pushing [ⓂCLR], [Ⓜ∇] and [MONI], push [POWER] for 2 sec. to reset the CPU.

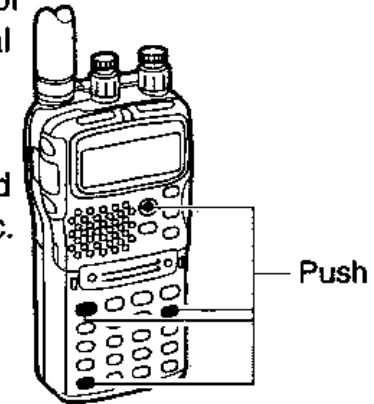

**CAUTION:** Resetting the CPU returns all programmed contents to their default settings.

## ■ Partial reset

AT POWER ON

If you want to initialize the operating condition (VFO frequency, VFO settings, set mode contents) without clearing the memory contents, repeater memories, clock or timers, a partial resetting function is available for the transceiver.

- ➔ While pushing [ⓂCLR], push [POWER] for 2 sec. to partially reset the transceiver.

# 16 MODE ARRANGEMENT

Although the following chart refers mainly to the VHF band, the same mode arrangement applies to the UHF band.

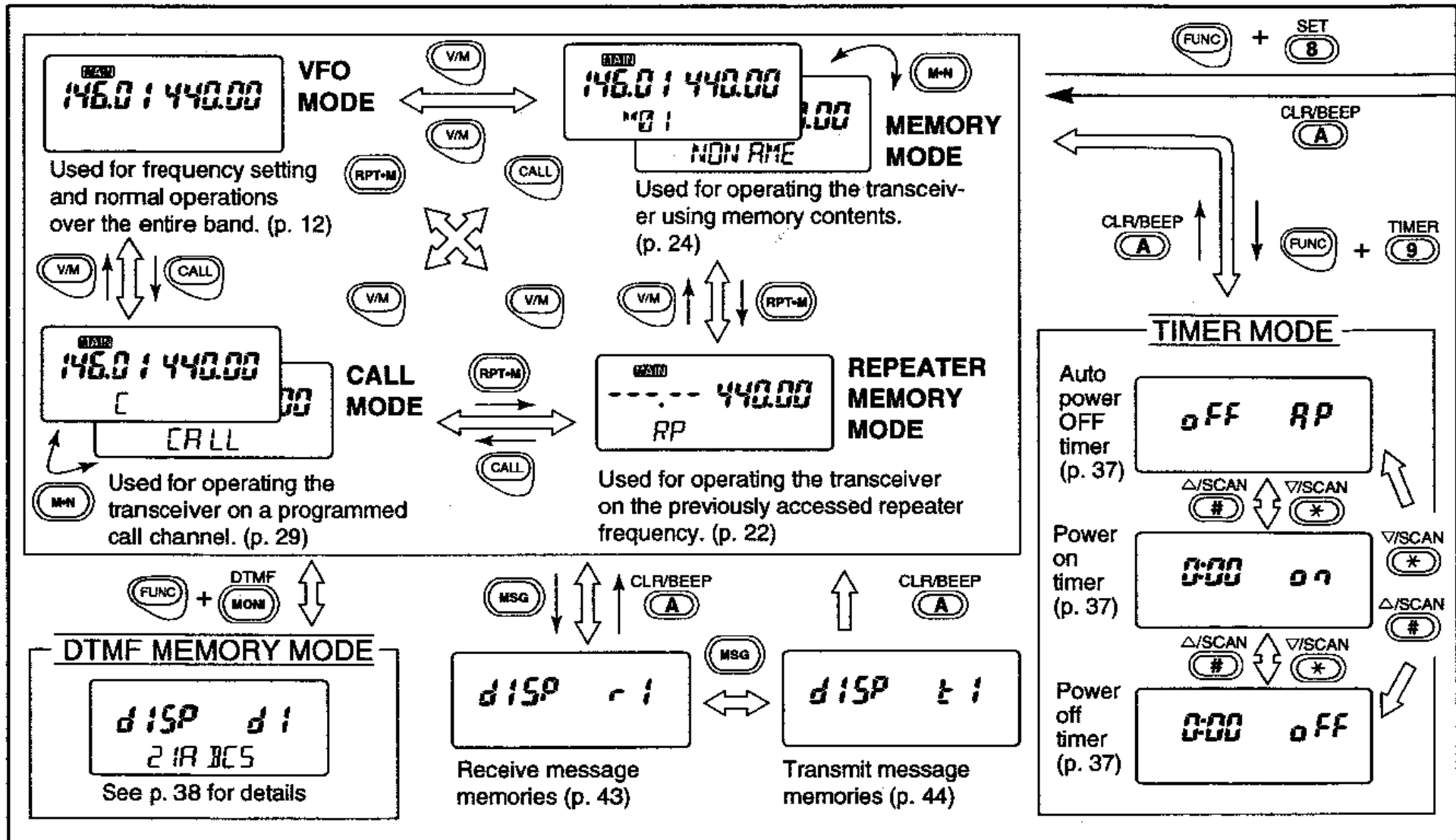

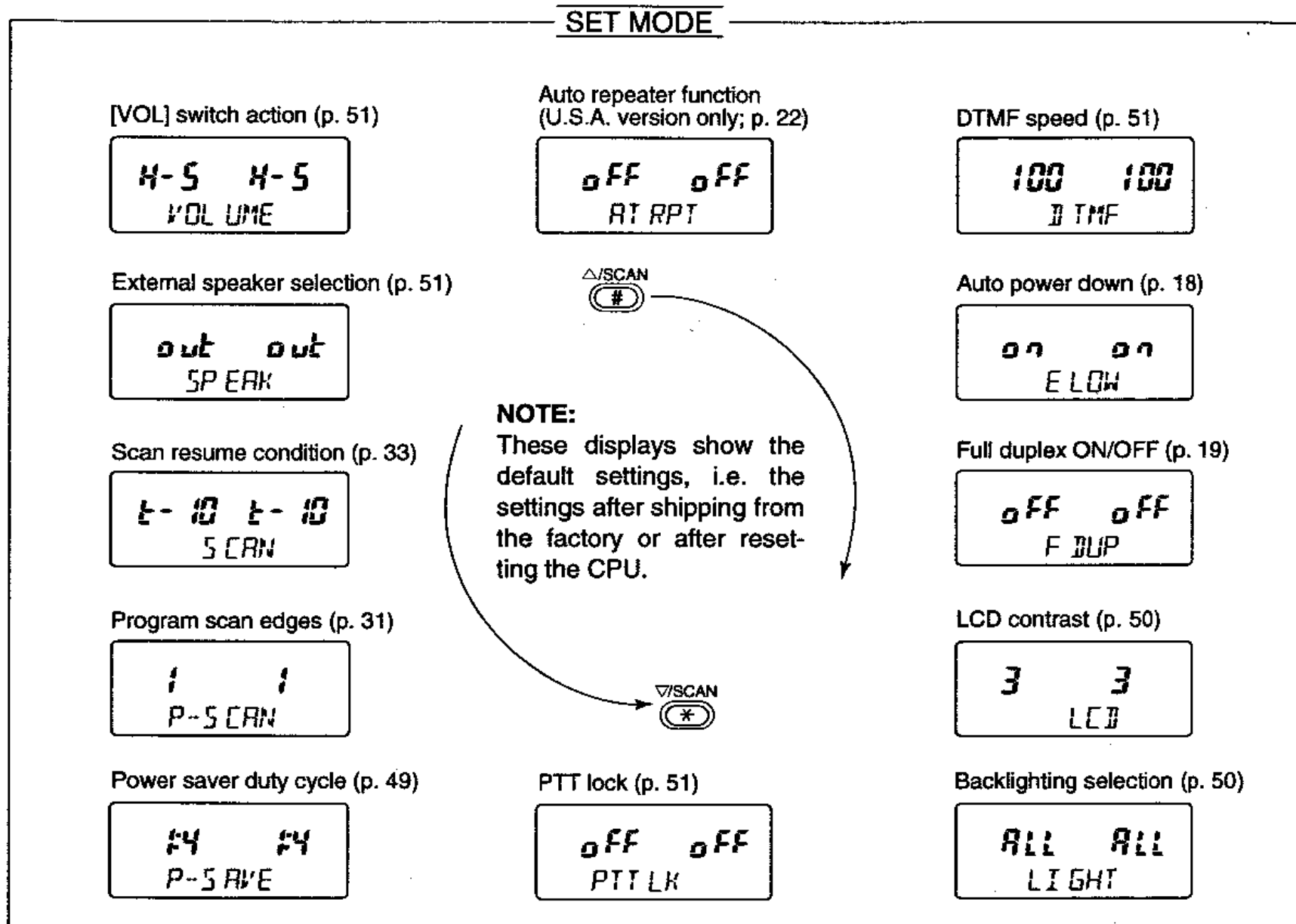

# 17 TROUBLESHOOTING

If your transceiver seems to be malfunctioning, please check the following points before sending it to a service center.

PROBLEM	POSSIBLE CAUSE	SOLUTION	REF.
<ul style="list-style-type: none"> <li>No power comes on.</li> </ul>	<ul style="list-style-type: none"> <li>The battery is exhausted. (A slight current flows in the circuits even when the power is OFF).</li> <li>Poor plug connection to the external DC power cable.</li> </ul>	<ul style="list-style-type: none"> <li>Charge the battery pack or place new dry cell batteries in the battery case. (Remove the battery pack if you will not be using the transceiver for a long time.)</li> <li>Check the connector or remove and replace the cable.</li> </ul>	<p>pgs. 10, 11</p> <p>—</p>
<ul style="list-style-type: none"> <li>Power cannot be turned OFF</li> </ul>	<ul style="list-style-type: none"> <li>The battery became exhausted during operation.</li> </ul>	<ul style="list-style-type: none"> <li>Charge the battery pack or place new dry cell batteries in the battery case, then, turn the power OFF.</li> </ul>	<p>pgs. 10, 11</p>
<ul style="list-style-type: none"> <li>No sound comes from the speaker.</li> </ul>	<ul style="list-style-type: none"> <li>[SQL] is turned too far clockwise.</li> <li>Pager or code squelch is activated.</li> </ul>	<ul style="list-style-type: none"> <li>Rotate [SQL] counterclockwise.</li> <li>Push [©PGR/CS] once or twice to turn the function OFF.</li> </ul>	<p>p. 16</p> <p>pgs. 41, 43</p>
<ul style="list-style-type: none"> <li>Transmitting is impossible.</li> </ul>	<ul style="list-style-type: none"> <li>The battery is exhausted.</li> <li>PTT lock function is activated.</li> </ul>	<ul style="list-style-type: none"> <li>Charge the battery pack or place new dry cells in the battery case.</li> <li>Turn the function OFF.</li> </ul>	<p>pgs. 10, 11</p> <p>p. 51</p>
<ul style="list-style-type: none"> <li>Frequency cannot be set.</li> </ul>	<ul style="list-style-type: none"> <li>Memory mode, call channel or repeater memory is selected.</li> <li>The lock function is activated.</li> </ul>	<ul style="list-style-type: none"> <li>Push [V/M] one or more times to select VFO mode.</li> <li>Push [FUNC] then [LOCK] to deactivate the lock function.</li> </ul>	<p>p. 12</p> <p>p. 15</p>
<ul style="list-style-type: none"> <li>Cannot receive "messages".</li> </ul>	<ul style="list-style-type: none"> <li>Pager or code squelch is not activated and/or the message function is not activated.</li> </ul>	<ul style="list-style-type: none"> <li>Activate pager or code squelch with [©PGR/CS] in advance.</li> </ul>	<p>pgs. 41, 43</p>
<ul style="list-style-type: none"> <li>Scan cannot be activated.</li> </ul>	<ul style="list-style-type: none"> <li>The squelch is open.</li> </ul>	<ul style="list-style-type: none"> <li>Rotate [SQL] clockwise until noise disappears.</li> </ul>	<p>p. 16</p>
<ul style="list-style-type: none"> <li>Clock shows incorrect time and timer settings are erased.</li> </ul>	<ul style="list-style-type: none"> <li>The internal backup battery is exhausted because no charging has been performed for a long time.</li> </ul>	<ul style="list-style-type: none"> <li>Reset the timer(s) and clock again, then charge the battery pack or place new dry cells in the battery case.</li> </ul>	<p>pgs. 10, 11, 35, 36</p>

# SPECIFICATIONS 18

		VHF		UHF		
		U.S.A	Tx: 144-148 Rx: 136-174* <sup>1</sup>	Tx: 440-450 Rx: 400-470* <sup>2</sup>	Italy	Tx: 144-148 Rx: 136-174* <sup>1</sup>
Frequency coverage (MHz)		Eur, U.K.	144-146	430-440	Asia	Tx: 144-148 Rx: 140-150* <sup>1</sup>
	Guaranteed ranges are:					
	* <sup>1</sup> 144-148					
	* <sup>2</sup> 440-450					
	* <sup>3</sup> 440-470					
Mode		FM (F3E)				
Frequency stability		± 5 ppm (0°C to +50°C; +32°F to +122°F)				
Tuning steps		5, 10, 12.5, 15, 20, 25, 30 or 50 kHz				
Antenna impedance		50 Ω (nominal)				
Usable battery pack/case		See options on page 57.				
External DC power		4.5 to 16 V DC (negative ground)				
Current drain (at 13.5 V, typical)	Tx	High	1.3 A	1.5 A		
		Low	500 mA	600 mA		
	1 band Rx	Rated audio	160 mA	170 mA		
		Power saved	23 mA (average)	25 mA (average)		
2 bands Rx	Rated audio	210 mA				
	Power saved	34 mA (average)				
Usable temperature range		-10°C to +60°C (+14°F to +140°F)				
Dimensions (with BP-171) (projections not included)		57(W)x125(H)x36(D) mm; 2.2(W)x4.9(H)x1.4(D) in				
Weight (with BP-171 and antenna)		380 g; 13.4 oz				

		VHF		UHF	
		Output power* (at 13.5 V)		5 W, 0.5 W, 15 mW (selectable)	
TRANSMITTER	Modulation system	Variable reactance frequency modulation			
	Max. freq. deviation*	±5.0 kHz			
	Microphone impedance	2 kΩ			
RECEIVER	Receive system	Double conversion superheterodyne			
	Intermediate frequencies	1st	43.1 MHz	35.8 MHz	
		2nd	455 kHz		
	Sensitivity* (12 dB SINAD)	Less than 0.16 μV (Less than 0.32 μV for V/V and U/U)			
	Squelch sensitivity	Less than 0.16 μV (at threshold)			
	Selectivity	More than 15 kHz/-6 dB Less than 30 kHz/-60 dB			
	Spurious and image rejection ratio*	More than 60 dB (More than 45 dB at IF/2)			
	Audio output power* (at 13.5 V)	More than 180 mW (at 10% distortion with an 8 Ω load)			
Audio output impedance	8 Ω				

\*Specifications guaranteed at a transceiver temperature of +25°C (+77°F).

**All stated specifications are subject to change without notice or obligation.**

# 19 OPTIONS

BATTERY PACK	HEIGHT	VOLTAGE	CAPACITY	OUTPUT POWER	CARRYING CASE
BP-170	63.5 mm/2.5 in	Battery case for R6(AA) x 4 dry cells		1.3 (1.5) W	LC-123
BP-171	63.5 mm/2.5 in	4.8 V	700 mAh	1.3 (1.5) W	LC-123
BP-172	63.5 mm/2.5 in	4.8 V	950 mAh	1.3 (1.5) W	LC-123
BP-173	75.5 mm/3.0 in	9.6 V	650 mAh	4.5 (5) W	LC-124
BP-180	75.5 mm/3.0 in	7.2 V	600 mAh	3.5 (3.5) W	LC-124

Bracketed values in the output power column refer to the UHF band.

**CP-12**  
CIGARETTE LIGHTER  
CABLE WITH NOISE FILTER  
For operation and charging via  
a 12 V cigarette lighter socket.

**OPC-254**  
DC POWER CABLE  
For operation and charging via  
an external power supply.

**BC-74A/E/D, BC-110V**  
WALL CHARGER  
Regularly charges a battery  
pack.

- The BC-73E/D cannot be used as the charging power source.

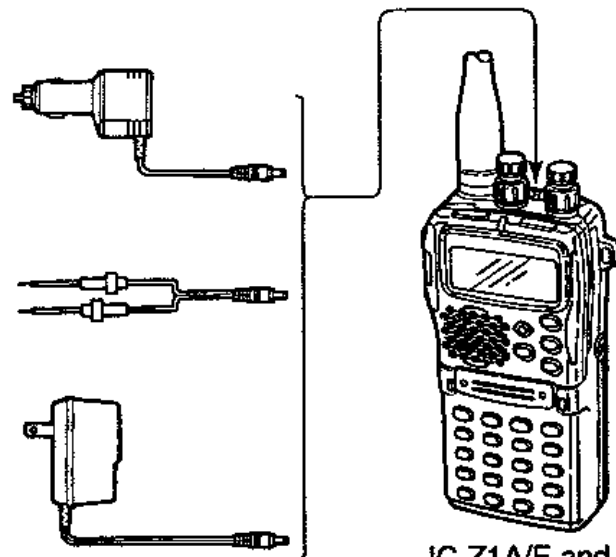

IC-Z1A/E and  
attached battery  
pack.

## BC-79 DESKTOP CHARGER + AD-51 BATTERY PACK ADAPTER

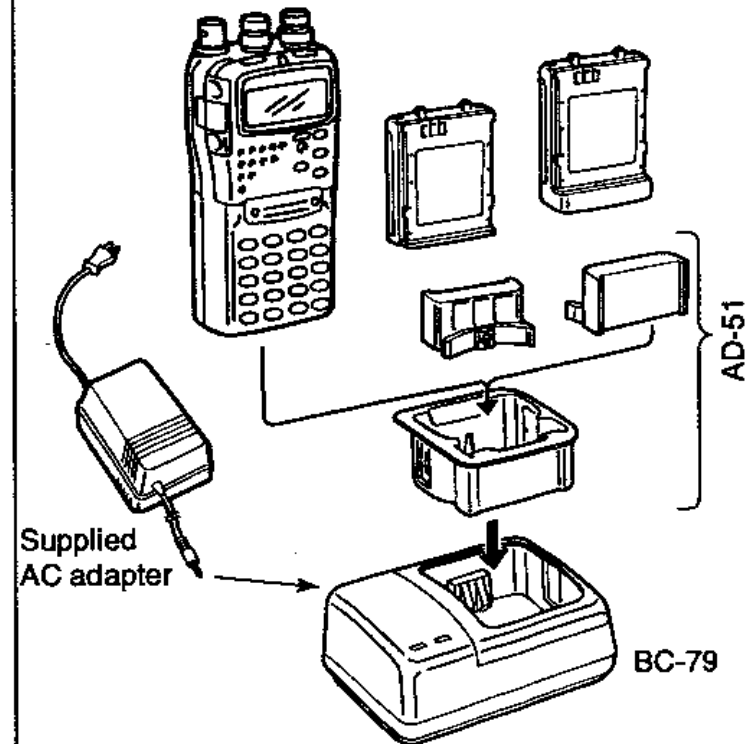

- Rapid charging takes 1 to 1.5 hr. depending on battery pack being charged.
- An AC adapter is packed with the BC-79.
- The CP-13/L or OPC-288 can be used instead of the supplied AC adapter.

◇ Speaker-microphones

HM-46

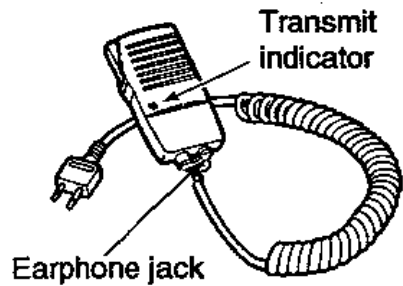

Transmit indicator

Earphone jack

HM-54

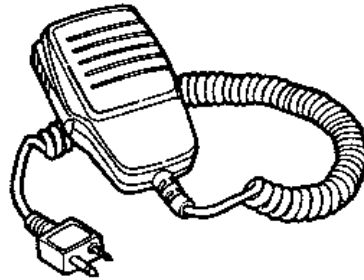

MB-30 MOUNTING BRACKET

When using the bracket hanger

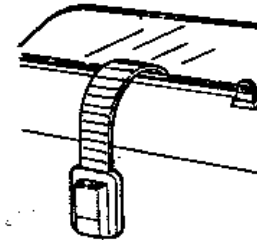

When using no bracket hanger

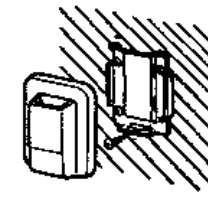

HM-75/A

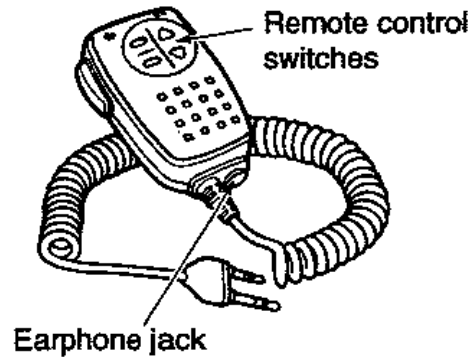

Remote control switches

Earphone jack

HS-85 HEADSET

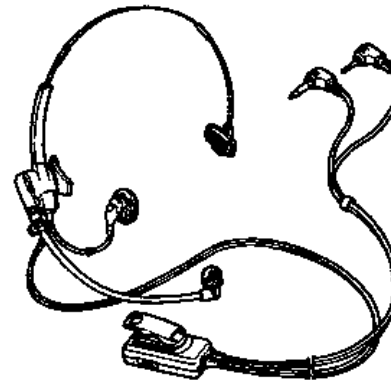

- PTT switch
- VOX
- One-touch PTT for hands-free operation

Note that the HS-51 cannot be used since the transceiver applies 3.5 V via the [MIC] jack.

**SP-13 EARPHONE**

Provides clear receive audio in noisy environments.

**UT-93 TONE SQUELCH UNIT**

Provides a "personalized" tone squelch system with other stations and tone scan functions. Also functions as a programmable tone encoder. The U.S.A. version includes this unit as standard.

**Count on us!**



A-5332S-1EX-②  
Printed in Japan  
Copyright © 1994 by Icom Inc.

**Icom Inc.**  
6-9-16, Kamihigashi, Hirano-ku, Osaka 547, Japan